

Security Command[®]
EXECUTIVE SERIES

XR200-485

User's Guide

Silencing an Alarm

1. While the alarm bell or siren is sounding, press the COMMAND key until **MENU? NO YES** appears and press the select key under **YES**. Enter your user code and press the COMMAND key until **ALARM SILENCE** appears. Press any top row select key. The system silences the alarm bell or siren.
2. If your system is programmed to send an Abort (alarm cancel) report to the central station, the keypad displays **ALARM CANCELLED**.

Copyright © 1997 - 2003 Digital Monitoring Products, Inc.
Information furnished by DMP is believed to be accurate and reliable.
This information is subject to change without notice.

XR200-485 Command Processor™ Panel User's Guide

Table of Contents

Introduction	1	Outputs On Off	15
About Your Security System	1	Turning the Outputs ON and OFF	15
Emergency Evacuation Plans	2	Zone Status	16
The Security Command Keypad	2	Using the Zone Status Function	16
Special Security Command Tones	4	Bypass Zones	17
Special Security Command Displays	4	Using the Bypass Zones Function	17
Special Wireless Displays	5	Zone Monitor	17
Understanding Security System Terms	6	Using the Zone Monitor Function	18
General Arming Operation	8	System Status	18
System Arming	9	Using the System Status Function	18
Arming the System	9	System Test	19
General Disarming Operation	10	Using the System Test Function	19
Disarming the System from the keypad	11	XR200-485B Panic Test	19
Extending Schedules	11	User Profiles	20
		Adding User Profiles	20
Security Command User Menu	12	User Profiles Chart	21
Alarm Silence	13	User Codes	23
Using the Alarm Silence Function	13	Forgive Failure to Exit	25
Sensor Reset	13	Ambush Codes	25
Resetting the Sensors	13	Schedules	26
Door Access	14	Setting the Date and Time	31
Using the Door Access	14	Setting the System's Date and Time	31
Armed Areas Display	14	Display Events	31
Using the Armed Areas Function	14	Service Request	33
		Fire Drill	33

XR200-485B User's Guide Supplement	34
Two Man Rule	34
System and Panic Zones Test	34
Using the System Test	34
Using the Panic Zone Test	35
Testing your system's burglary protection	35
Bank Safe & Vault	35
System Setup	36
System Setup Record	36
485B System Setup Record	36
Security Command Keypad Record	37
Area Names and Numbers Record	37
User Codes Record	39
Schedules Record	40
Holiday Date Record	41
Output Relay Record	41
Appendix A	42
About the Display Events Section	42
Arming and Disarming Event Displays	42
Zone Event Displays	42
User Code Change Event Displays	43
Supervisory Event Displays	43
System Monitor Event Displays	44
Door Access Event Displays	44
Schedule Change Event Displays	45
Zone Bypass Event Displays	45

Appendix B	46
Outputs On/Off Browser	46
Zone Status Browser	46
Bypass Zones Browser	47
Zone Monitor Browser	47
Add User Profiles Browser	48
Delete User Profiles Browser	48
Change User Profiles Browser	49
Add User Codes Browser	49
Delete User Codes Browser	50
Change User Codes Browser	50
Output Groups Browser	51
Entering User Names	51

Appendix C	52
Easy Entry™ User's Guide	52
Using the access reader for user menu access	52
Pager Direct™ User's Guide	53
FA113 User's Guide	55
Disarming the System	55
Arming an Area System	55
Disarming an Area System	55
Using the ALERT Buttons	55
Frequently asked questions	56

Appendix D	57
Common Keypad Displays	57
Common Keypad Displays Continued	58

Index	59
--------------------	-----------

Introduction

About Your Security System

The Security Command system has been designed with your safety and comfort in mind. It uses the latest in computer based technology to create the most advanced, user friendly security, fire, and access control system available.

The Security Command system combines ease of use with a simple to understand Security Command keypad to offer the full range of features requested by today's security system owners.

Use the Security Command system to turn portions of your protection on or off by pressing a few keys, or have the system turn on or off automatically by entering a simple schedule. You can add, delete, and change personal user codes at any time or check the status of protection devices in the system.

Parts of the System

There are two main parts to the Security Command system, the Security Command keypad and the keypad User Menu.

Security Command Keypad

This is the device we have placed at certain locations throughout the premises that allow you to turn the system's protection on and off using your personal user code.

Keypad User Menu

The keypad provides a simple User Menu containing all of the functions you need to fully operate your system such as changing the time of day or a personal user code.

A Note About False Alarms

One of the most important concerns facing the security industry today is false alarms. The accidental dispatching of police and fire agencies places others in jeopardy by limiting the response capability of those emergency service units. We take this concern seriously and have spent many hours training our employees to recognize the causes of false alarms and prevent them from occurring.

As part of our commitment to reducing false alarms, we would like to encourage you to read this guide thoroughly. All the information contained here can help you quickly, and comfortably, learn the operation of the Security Command system. If you have any additional questions, or feel that you need more training, please do not hesitate to contact us.

Test Your System Weekly

It is recommended that you test the burglary portion of your system at least once each week. Testing should involve an active test of all doors, windows, and motion detectors connected to your system. If your system also has fire protection, call the service department to find out how this portion of your system should be tested.

Refer to the System Test section of this guide for instructions on testing the burglary portion of your system and refer to the Fire Drill section for instructions on testing your system fire bells.

Emergency Evacuation Plans

The National Fire Protection Association recommends that you establish an emergency evacuation plan to safeguard lives in the event of a fire or other emergency. Use the following steps as a guide.

Draw a floor plan of your home or business

On a clean sheet of paper, draw the walls, windows, doors, and stairs. Also draw any obstacles that a person may encounter while exiting the building such as large furniture or appliances.

Develop escape routes

Determine at least two routes the occupants in each room can take to safely escape. One route can be the most obvious such as the door. Another can be through a window that can be easily opened. If the window is high off the ground, an escape ladder should be provided.

Draw arrows on the floor plan to show escape routes from each room.

Decide where to meet

Prearrange a meeting place outside and away from where emergency personnel are likely to be working. A neighbor's house or across the street in the front of the house are good locations. Always perform a head count to make sure all occupants safely exited. **NEVER ENTER A BURNING BUILDING.** If the head count shows one or more persons missing, give this information immediately to the authorities. Never enter a building to look for someone.

Practice your escape plans

Devising an escape plan is only the beginning. For the plan to be effective everyone should practice the escape routes from each room.

Early detection

The best way to survive a fire or other emergency is to get out early. The installation of a fire alarm system, with smoke and carbon monoxide detectors in each room, can greatly decrease your risk of loss or injury.

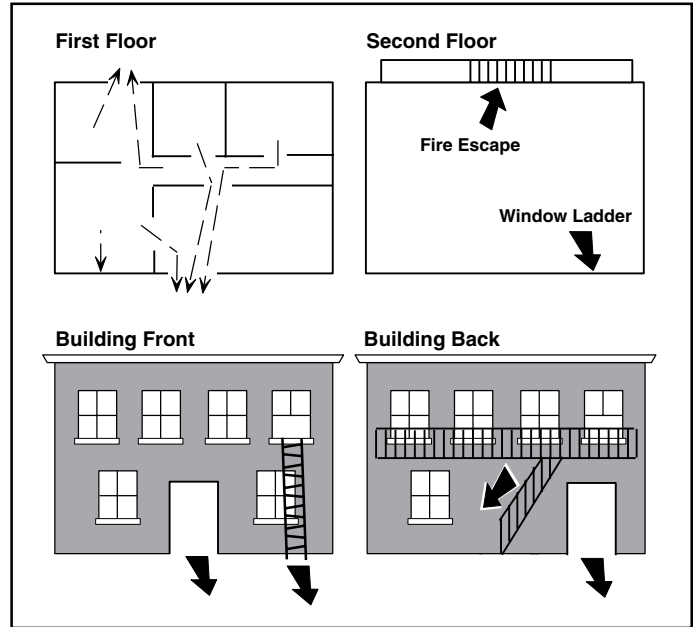

Sample Floor Plan

The Security Command Keypad

Your system may have one or more easy to use Security Command keypads (16- or 32-character) that allow you to properly operate the system. The illustration and descriptions below highlight some of the keypad features:

The Select keys

There are four keys under the display called the Select keys. These keys are one of the features that make your system so easy to operate by allowing you to make selections by pressing the Select key under choice being shown in the display.

For the purposes of this guide, when instructed to press the first Select key, press the far left Select key; the second Select key is the second from the left; third Select key is second from the right; and the fourth Select key is the far right key.

Data Entry keys

These keys allow you to enter your user code when arming or disarming or enter other information into the system.

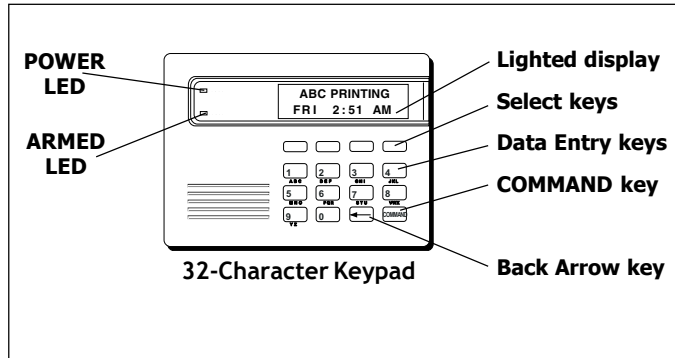

The Back Arrow key

The Back Arrow key is used to go back through the keypad displays while operating your system. You can press the Back Arrow key to back up through the list of functions in the User Menu or to erase the last character you entered.

The COMMAND key

The COMMAND key allows you to advance through the keypad displays or User Menu or complete a data entry function.

POWERLED

This LED remains on steady as long as your system is connected to its AC power supply. Should there be an interruption, the LED turns off and the system's backup battery maintains normal operation for a time so you can contact the service department.

ARMED LED

This LED is ON steady anytime a burglary protection area is armed and is OFF when ALL areas are disarmed.

2-Button Panic Keys

Your keypad may be set up to send a Panic, Emergency, or Fire report to the central station. This function is optional. An icon label should appear above the Select keys if this option is programmed for your keypad.

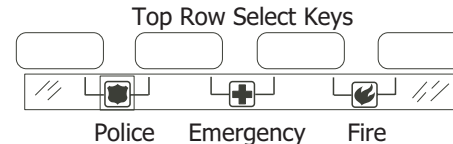

To send a panic, press and hold the two Select keys for 2 seconds, until a beep from the keypad is heard.

32-Character Keypad User Options Menu

Press and hold the Back Arrow and COMMAND keys for about two seconds. The keypad display shows **SET BRIGHTNESS**. Use the first Select key to lower the display brightness or the fourth Select key to increase the brightness. Press COMMAND.

At **SET TONE**, use the first Select key to lower the keypad tone or the fourth Select key to raise the tone. Press COMMAND.

At **SET VOLUME LEVEL**, use the first Select key to lower the keypad volume or the fourth Select key to raise the keypad volume. Press the Back Arrow key to exit the User Options menu.

Special Security Command Tones

Your keypad also contains a small speaker that alerts you about events as they occur on your system. Below are brief descriptions of the different tones you will hear from the keypad:

Fire Alarm tone: An intermittent sweeping siren that sounds until the fire alarm is silenced. From LCD keypads only.

Burglary Alarm tone: A constant siren tone that continues until the alarm is silenced. From LCD keypads only.

Key press tone: A short beep each time you press a key on the keypad and it's acknowledged by the system.

Prewarn tone: A continuous pulsed tone that sounds when you open an entry delay door on a system that is armed (turned on) reminding you to disarm the burglary protection.

Monitor tone: A pulsed tone for one second, one pulse only that sounds whenever a door or window is opened while you are using the zone monitor function from the User Menu. LCD keypads sound a doorbell chime. See Zone Monitor.

Trouble tone: A steady tone indicating a trouble condition on your system. Press a Select key to silence.

What to do when the trouble tone is sounding

You can silence the trouble tone by pressing any key. This only silences the keypad and does not correct the condition that originally caused the trouble.

Special Security Command Displays

As you use your system, you will occasionally see a keypad display that asks you to enter a code or that describes a condition on the system. Below are some examples of the displays you will see:

ALARM

A 24-hour zone (for example fire or panic) or an armed burglary zone has been tripped. Your system may sound bells or sirens.

TROUBLE

There is a problem with a protection device or system component. This display is accompanied by a description of the problem.

ENTER CODE

The system requires you to enter your user code. User codes can be required for turning your system on (arming), turning your system off (disarming), and many other functions.

As you enter your user code, the keypad display shows an asterisk (*) in place of each digit pressed. This keeps others from seeing your user code on the display as it's entered.

TRY AGAIN or INVALID CODE

The user code you have entered is not recognized by the system. Check the user code and try again.

INVALID PROFILE

All user codes have a profile that allow the user to only access certain functions. When users attempt functions outside their authority, the **INVALID PROFILE** message displays.

INVALID AREA

A user has attempted a door access for an area they are not assigned.

INVALID TIME

A user code assigned to a specific schedule has been entered outside of the valid schedule. See Schedules and User Codes.

ARMED AREA

A user has attempted a door access to an armed area to which they do not have arming and disarming capability.

FAILED TO EXIT (ANTI-PASS BACK)

Anti-pass requires users to properly exit (egress) an area they have previously accessed. If they fail to exit through the proper card reader location they will not be granted access on their next attempt. If a Failed to Exit message appears, a user assigned the anti-pass back option has attempted to re-enter an area which they did not exit properly. The user must exit the area through the proper door. If not possible, your system administrator should select the Forgive option in the User Codes menu option.

SYSTEM TROUBLE or SERVICE REQUIRED

There is a problem with one or more of the components in your system. Contact our service department as soon as possible.

SYSTEM BUSY

The Security Command system is performing another task of a higher priority. This usually only takes a few moments.

Special Wireless Displays

Your system may use radio transmitters to send alarm and trouble information from the protection devices to the panel. Wireless systems operate the same as hard-wired and also have a few unique keypad displays.

BACK DOOR - LOBAT - (Low Battery) The battery in a radio transmitter is low. (BACK DOOR is used as an example only.)

BACK DOOR - MISNG - (Missing) The panel is not receiving the radio transmitter's periodic test report.

WIRELESS - TRBL - (Trouble) Some part of your wireless system is operating improperly. Test the system to locate the trouble.

Understanding Security System Terms

Throughout this guide, and in some displays on your keypad, you will see certain words or phrases that might be unfamiliar. Below are some terms you will see here and on your keypad display:

Areas

An area is made up of burglary zones that can be armed or disarmed together. One area might consist of the office doors and windows. When you arm the office, these zones arm together and sound an alarm if opened.

An area also constitutes a place that can be accessed by entering a code at the keypad.

Arming

This is the term used for turning on the burglary protection in one or more areas of the system. Your system may require you to enter a user code. When armed, the system is able to sound alarm bells or sirens and, if monitored, send alarm reports to a central station when a burglary zone is tripped.

Fire, panic, and other 24-hour devices are always turned on and do not need to be armed.

Fault

In some cases you may see the keypad display **FRONT DOOR – FAULT**. This means that there is a problem with the front door, such as the door being open when you are arming the system. If you see a **–FAULT** display, attempt to correct the problem (in this case shut the door). After the zone is in a normal state again, you may arm the system. You may also bypass the zone and then arm the system.

Central Station Monitoring

Your system can also be programmed to automatically send alarm, trouble, and arming and disarming reports to a central station. Operators at the central station can in turn dispatch the appropriate authorities or contact you with the specific event information.

Disarming

This means turning off one or more areas of the system. When disarmed, the system does NOT sound alarms or send alarm reports to a central station when a burglary zone is faulted.

Door Access

Entry/Exit doors that are used to restrict access to the building provide door access to authorized users. When a user code is entered at the keypad by entering a code or presenting a card to a reader, the system verifies authority and unlocks the door for a short period of time. See Easy Entry™ User's Guide in Appendix C.

Entry or Exit zone

Almost all systems have one or more doors through which you can enter or exit the premises. These doors are programmed with a delay time to allow you to enter or exit without setting off the alarm.

When you arm the system, activity on this zone is ignored until the programmed exit delay time expires. Once that time has expired and the system is fully armed, opening the door causes the panel to start the *entry* delay time. During the entry delay time, you must enter a valid user code to disarm the system or an alarm will occur.

Status

Status is a feature that automatically displays the armed or disarmed status of your system on the Security Command keypads. Alarm or trouble conditions on a zone or a system monitor such as AC or battery trouble can also be displayed. There are two types of status information available: **Armed Status** and **Status List**.

Armed Status

With Armed Status, the keypad displays the current armed condition of areas within your security system. For example:

When you arm areas 1 to 4, the keypad shows = 1 2 3 4

When you arm areas 1 and 3, the keypad shows = 1 3

Also, for keypads that include an Armed LED, the Armed LED is ON steady anytime a burglary protection area is armed and is OFF when ALL areas are disarmed.

Status List

The keypad Status List displays any alarm or trouble condition on a zone, and any trouble condition on an internal system monitor. The system monitors include the AC power, battery power, panel box tamper, printer, and phone lines. If more than one alarm or trouble condition occurs at the same time, the keypad sequences this information on its display.

If the alarm is from a 24-hour zone or a system monitor, it remains in the Status List until it restores. If one or more armed burglary zones trip at the same time, the last one to trip remains in the Status List. This is to ensure that if a burglary has occurred the last zone tripped remains displayed even if it has been restored.

View Zone Status

To view the disarmed zones that are in fault, press any Select key when the status list is displayed.

Zone

A zone refers to one or more protected openings (doors or windows) or protection devices (motion or glassbreak detectors) grouped together under the same zone name and number.

Often, similar devices in the same general area will share the same zone. For example, the windows on the east side of the premises can all be grouped together in a zone named **E. WINDOWS**.

Instant Zone

Interior protection devices and perimeter devices, such as exterior windows, passive infrared detectors, and non entry doors, are typically not programmed with delay times. If these zones are tripped while the system is armed, an alarm occurs instantly.

24-hour Zone

A 24-hour zone is **not** turned on or off by arming or disarming your system. Some examples of 24-hour zones are fire zones, panic zones, and temperature control zones.

General Arming Operation

Your burglary protection is divided into areas. Each area has a custom name. Areas can be turned on or off independent of other areas and can have different schedules and authorized users.

After making your arming selection, the keypad displays any zones that are currently bypassed. These zones remain bypassed until the system is armed and then disarmed. Any 24-hour zones in a faulted condition are also displayed.

Before arming, the system verifies that all doors, windows, and other protection devices to be armed are in normal condition. If everything is okay, the system arms. If there is a problem on one or more burglary zones, the system cannot arm until the problem is corrected. If the problem is simply an open door or window, correct the problem and try arming again.

If the problem cannot be corrected, you can force arm or bypass the zone or wait until the zone can be repaired by a service technician. A **force armed** zone is ignored by the system until it restores to normal. A **bypassed** zone is ignored by the system during the entire armed period. A zone remains bypassed until the system is disarmed.

In some cases, you might see the keypad display **FRONT DOOR – FAULT**. The keypad will then display **PRIORITY ZONE** which is a zone that cannot be bypassed. The problem on the zone must be corrected before the system can be armed.

Armed Message: After all bypassing is completed or zone faults corrected, the keypad briefly displays **ALL SYSTEM ON** if all areas in the system are arming and **SYSTEM ON** if only selected areas are arming. The keypad then displays the exit delay time as it counts down. When the exit delay time expires, all disarmed zones are armed.

If your system uses a keyswitch to arm an area, the exit delay time is **NOT** shown on the keypad display.

ONE MOMENT . . . Message: If your system is monitored, it may be programmed to wait for the transmission of an arming report to the central station before displaying the armed message. (See Arming Report below.) This is to verify your phone lines are working properly. While the system is waiting for the transmission, the display reads **ONE MOMENT....** If the report is received, the keypad displays the armed message. If the report is not received, the keypad displays **LOCAL ALARM ONLY** before displaying the armed message.

Arming Report: Your system can be programmed to send arming or zone bypassing reports to a central station. This feature is optional and can be programmed for you at any time.

System Arming

Area Assignment: Your security system has been set up into separate areas. The number of areas and their names are listed in the back of this guide.

Arming or Disarming: You can arm and disarm all areas at one time or each area individually. You can only arm or disarm areas authorized for your user code.

Arm all or Selective Arming: After entering your user code, the system allows you to arm either all of the areas to which you have access or one or more selected areas. If you choose to arm all areas, the system begins verifying that all zones in those areas are in a good condition. If you choose to arm selected areas, the system prompts you to choose the areas you want to arm.

Arming the System

1. Press the **COMMAND** key until **ARM** **DISARM** is displayed.
2. Select **ARM** to arm the system.
3. Enter your user code if required. The display reads **ALL? NO YES**.
4. Select **NO** to arm only selected areas. Go to step 5. Select **YES** to arm all areas authorized for your user code. Go to step 6.
5. If you selected **NO** in step 4, the display begins to list each area to which you have access followed by **NO YES**.
Example: **OFFICE NO YES**
 - 5a. Select **YES** for each area you want to arm.
 - 5b. Select **NO** for each area you do not want to arm.

Note: You can also just press the area numbers you want to arm while at the **ALL? NO YES** display. This changes the display to **AREAS: .** The area numbers you select appear in the display. For example: **AREAS: 2 4**. Press **COMMAND** when done.

6. The system displays any bypassed zones or faulted 24-hour or Priority zones. A faulted Priority zone cannot be armed.
7. At this point you can **force arm** or **bypass** any faulted zones. A zone that is force armed will be restored into the system if it later returns to normal. A zone that is bypassed will remain bypassed until the system is disarmed. See steps 7a through 7d.
 - 7a. If a problem exists on a zone, the zone name and problem is shown followed by: **OKAY BYPASS STOP**.
 - 7b. Select **OKAY** to force arm the faulted zone.
 - 7c. Select **BYPASS** to bypass all faulted zones being displayed.
Note: 24-hour zones cannot be bypassed.
 - 7d. Select **STOP** to stop the system from arming. Correct the zone problem(s) and return to step 1.
Your system may be programmed to require a user code that has authorization to force arm or bypass a faulted zone. The system will ask for a user code to be entered.
8. The display reads **SYSTEM ON** if at least one area in the system is armed, and **ALL SYSTEM ON** if all areas in the system are armed.
9. The keypad then displays the exit time in seconds and counts down the remaining time: **EXIT : ## (## = seconds remaining)**. The exit zones arm when the delay time expires.

General Disarming Operation

While the system is armed, you can only enter the premises through an entry/exit delay door without causing an alarm. After opening the door, the Security Command keypad sounds a prewarn tone to remind you to disarm the system. (See Door Access Disarming below.) You must disarm the system before the entry delay time expires or an alarm on the door zone will occur.

During the entry delay time, the keypad displays **ENTER CODE:**. Enter your code to disarm the system. Only those areas assigned to your code will disarm.

When you present your card to an outside reader to gain access and your code has authority to disarm, those areas assigned to the door which match areas assigned to your code will automatically disarm. Enter code is not displayed.

Schedules: If you have programmed schedules for your system and a code is entered outside of a schedule and that code does not have authorization to disarm outside of schedules, the keypad displays **INVALID TIME**. This lets the users know that they are disarming outside of their authorized time. If your system is monitored, an Unauthorized Entry report is sent to the central station.

All or Selective Disarming: After entering your user code, the system allows you to disarm either all of the areas to which you have access or just selected areas. If you choose to disarm all areas, the system automatically disarms them. If you choose to disarm selected areas, the area names will be displayed on the keypad.

Alarm Display: After disarming, the keypad displays any zones that tripped or any transmission problems that occurred during the armed period. All burglary zones are then disarmed and any bypassed zones are automatically reset.

Disarmed Message: The keypad displays **ALL SYSTEM OFF** after the system disarms.

Central Station Report: A report of the system disarming can be transmitted to the central station. This is optional and can be programmed for you at any time.

Door Access Disarming: Your system may be programmed to allow disarming of areas when a card is presented to a door access reader located outside of the building. Simply present your card to the reader and after the card's code is validated for the appropriate authority, a door access is granted and your matching areas are automatically disarmed. See the Easy Entry™ User's Guide in Appendix C.

Disarming the System from the keypad

1. Press the **COMMAND** key until **ARM DISARM** is displayed. During entry delay this process starts at step 3.
2. Select **DISARM** to disarm areas.
3. The keypad displays **ENTER CODE: .** Enter your user code and press **COMMAND**. The keypad displays **ALL? NO YES**.
4. Select **YES** to disarm all areas authorized for your user code. Select **NO** to disarm only certain areas individually. The keypad then displays the name of each area authorized for your user code followed by the **NO YES** display. Choose **YES** to disarm the area displayed. Choose **NO** to not disarm and to display the next area.
Note: You can also just press the area numbers you want to disarm while at the **ALL? NO YES** display. This changes the display to **AREAS: .** The area numbers you select appear in the display. For example: **AREAS: 2 4**. Press **COMMAND** when done.
5. After all areas have been displayed, any alarms or communication problems that occurred during the armed period are displayed.
6. If all areas have been disarmed, the keypad next displays **ALL SYSTEM OFF**.

Extending Schedules

Depending on your system's programming, when the schedule expires (the ON time) you can extend the schedule to a later time. The keypad buzzer sounds and the keypad displays "area name" and **LATE** or **CLOSING TIME!**. This reminds users still on the premises to arm the system or extend the schedule.

To extend the system's schedule:

1. Press a Select key. The keypad will display **ENTER CODE:-**.
2. Enter your code and press **COMMAND** or present your access card to a valid reader. The system's schedule is automatically extended one hour.
3. The keypad then displays **:- AM PM**. You can enter a time to extend the schedule for greater than one hour. Press **AM** or **PM**.
Note: If the system is not armed by the scheduled closing time, a Late to Close report is sent to the central station. If the schedule is extended, a Schedule Change report is sent to the central station.

For information about extending a schedule before the scheduled closing time has been reached, see **Extending Schedules (EXT)** in the User Menu portion of this guide.

User Menu

Security Command User Menu

Many of the features of your system have been put into a User Menu that you can access from any Security Command keypad. The menu requires you to enter your user code and then it only shows those functions to which you have access.

To access the User Menu:

1. Press the COMMAND key until **MENU?** **NO YES** displays.
2. Select **YES**. The keypad displays **ENTER CODE: -.** Enter your user code and press COMMAND. You can now scroll down through the list of system features available to you.

User Menu Options

The list below shows the User Menu options in order:

Menu Option	Description
ALARM SILENCE	Silences an alarm bell or siren.
SENSOR RESET	Resets smoke or glassbreak detectors that have latched due to an alarm condition.
DOOR ACCESS	Momentarily opens the keypad's door lock relay.
ARMED AREAS	Displays the name of any areas in the system that are currently in the armed state.
OUTPUTS ON/OFF	Allows you to turn on or off any of the outputs described in the System Setup section of this guide.

ZONE STATUS	Allows you to see if a zone is either armed, bypassed, in alarm, open, or shorted.
BYPASS ZONES	Allows you to Bypass a zone or reset an already bypassed zone.
ZONE MONITOR	Allows you to add or remove a zone from the monitor mode.
SYSTEM STATUS	Displays the current condition of the system's AC power, backup battery, and panel tamper (optional).
SYSTEM TEST	Tests the system's siren, communication to the central station, and backup battery.
USER PROFILES	Allows you to change user profiles.
USER CODES	Allows you to add, delete, or change user codes.
SCHEDULES	Allows you to add, remove, or change system schedules.
TIME	Allows you change the Day, Date, or Time that is currently in the system.
DISPLAY EVENTS	Allows you to view or print the last 1,000 door accesses or 200 system events that occurred on your system.
SERVICE REQUEST	Allows you to send a message to the Central Station requesting service on the alarm system.
FIRE DRILL	Allows you to test the system's fire bells.

Alarm Silence

Silences the alarm bells or sirens during an alarm.

Alarm Silence allows you to turn off the alarm bells and sirens connected to your system during an alarm. Using Alarm Silence does NOT stop an alarm report from being sent to the central station and does not reset any alarmed devices. Use the Sensor Reset function to reset devices such as smoke detectors that have latched in alarm.

Note: You can also silence an alarm by entering your user code and pressing COMMAND or by presenting your card to a reader while the Status List is displaying. Matching areas assigned to your code are disarmed and a door access occurs.

Using the Alarm Silence Function

1. Access the User Menu.
2. The keypad displays **ALARM SILENCE?**.
3. Press any Select key to silence the bells and exit the User Menu.

Sensor Reset

Resets smoke or glassbreak detectors. Also clears Fire/Supervisory alarm and trouble displays.

Sensor Reset is used to reset smoke and glassbreak detectors after they have been tripped. Once these detectors have tripped, they must be reset before they can detect any additional alarm conditions. When Sensor Reset is selected, power to the detectors is temporarily removed by the system allowing them to reset.

Make sure all smoke is cleared from around the area of the smoke detectors before performing a Sensor Reset to prevent the alarm from occurring again.

Resetting the Sensors

1. Access the User Menu.
2. Press COMMAND until **SENSOR RESET** displays.
3. The keypad displays **SENSORS OFF** for five seconds followed by **SENSORS ON**.
4. The keypad automatically exits the User Menu.

Door Access

Operates an electric door strike from the keypad.

Door Access is used to operate a door strike relay that is built into some Security Command keypads. Power for the door strike is connected to the keypad relay and can be interrupted by using the Door Access function.

Door Access also operates by simply entering your user code and pressing **COMMAND** while the Status List is displaying. See Easy Entry™ User's Guide in Appendix C. If you are using a 793 keypad that has a built-in card reader, you may simply present your card to be given Door Access.

A report of this entry can be sent to your central station. This report is optional and can be programmed for you at any time.

Using the Door Access

1. Access the User Menu.
2. Press **COMMAND** until **DOOR ACCESS?** displays.
3. Press any Select key. The door strike relay turns on momentarily.
4. The keypad returns to the Status List display.

Armed Areas Display

Displays all armed area names in the system.

The Armed Areas display lists all of the names of the armed areas in your system at the Security Command keypads.

Using the Armed Areas Function

1. Access the User Menu.
2. Press **COMMAND** until **ARMED AREAS?** displays.
3. Press any Select key. The keypad displays the first armed area name. To scroll through the list of armed area names, press the **COMMAND** key.
4. If there are no armed areas, the keypad displays **NONE**.

Outputs On Off

Allows you to manually turn the system or door access relay outputs ON and OFF.

This function is used to individually turn your system's relay and access door outputs ON and OFF. Your system may use these outputs to control door access, interior and exterior lighting, heating, air conditioning, or other appliances.

The names and numbers of the relays connected to your system are located in the System Setup section of this guide.

Outputs can be turned ON or OFF regardless of the output settings in **Schedules**.

Your system may be programmed to require that your user code profile have access to areas assigned to the keypad. **INVALID AREA** is displayed when your user code does not have access to the keypad's areas and the output does not turn on.

Under certain conditions, some outputs cannot be turned on. If you select a restricted output, the keypad displays **CANNOT TURN ON**.

Turning the Outputs ON and OFF

1. Access the User Menu.
2. Press **COMMAND** until **OUTPUTS ON/OFF?** displays.
3. Press any Select key to display **OUTPUTS DOOR**.
4. Select the type of output you want to turn ON or OFF by pressing the Select key under **OUTPUTS** or **DOOR**.
5. Enter the output number you want to turn ON or OFF. The output number will appear in the display. The range for outputs is 1-10, 100-199, 200-299. The range for door is 1-16.
6. With the output number displayed, press the Select key under **ON** or **OFF**. The output is then turned ON or OFF depending on your Selection, and remains in that state until you change it. The keypad displays the first 12 characters of the output or door name followed by either ON or OFF for four seconds to provide visual verification of the action. Press the **COMMAND** key to end the four second display.
7. The system automatically returns to the output or door prompt and a new output can be selected to turn ON or OFF. Refer back to step 4.
8. Press the Back Arrow key to exit the User Menu.

Browser Feature

If you are unsure of the output number, refer to Appendix B at the back of this guide for a diagram showing you how to use the built-in **Outputs ON/OFF browser**.

Zone Status

Displays a list of armed, bypassed, or alarmed zones. Also allows you to check the status of individual zones. Zone Status can be used to give you a list of zones by category or display the current status of an individual zone number. The four categories are:

- **Armed Zones** - zones that are currently armed.
- **Bypassed Zones** - zones that are currently bypassed.
- **Alarmed Zones** - zones that have gone into alarm during the current or previous armed period.
- **Number** - enter the number of any zone to check its status.

Using the Zone Status Function

1. Access the User Menu.
2. Press COMMAND until **ZONE STATUS?** displays.
3. Press any Select key to display **ARM BYPS ALR NBR**.
4. Select **ARM** for a list of zones that are currently armed. You can scroll through the list by pressing the COMMAND key.
5. Select **BYPS** for a list of zones that are currently bypassed.
6. Select **ALR** for a list of zones that have gone into alarm during the current or previous armed period.

7. Press **NBR** and **ZONE NO:** - will be displayed.
8. At the **ZONE NO:** - prompt, enter the zone number you want to check and press COMMAND. The zone number and name is displayed followed by its status. For example, a zone status for zone 1 might be **BACK DOOR - OKAY**.

Below is a list of the zone status displays:

- OKAY = the zone is in a normal condition
- BYPAS = the zone is bypassed
- BAD = the zone is in a bad or faulted condition

9. After displaying the zone status, **ZONE:** - returns for you to enter another zone number.

Browser Feature

If you are unsure of the zone number or description, refer to Appendix B at the back of this guide for a diagram showing you how to use the built-in **Zone Status browser**.

Bypass Zones

Allows you to bypass a zone prior to arming.

Bypassing is usually done when a zone cannot be restored to normal. A significant benefit of bypassing a zone is to allow a zone in a faulted or bad condition to be bypassed so that arming can occur. The faulted zone can be serviced the next day.

A zone can be bypassed only while it is disarmed. Fire, panic, emergency, and supervisory type zones are always armed, so they can never be manually bypassed.

Bypass Zones can also be used to reset a zone that has been bypassed and restore it back into the system.

When Bypass Zones is selected, a report can be transmitted to your central station.

Using the Bypass Zones Function

1. Access the User Menu.
2. Press **COMMAND** until **BYPASS ZONES?** displays.
3. Press any **Select** key. The keypad displays **ZONE: - RST BYPS.**
4. To Bypass a zone, enter the zone number and select **BYPS.** The zone number automatically disappears and a new zone number can be entered. Refer back to step 3.
5. To Reset a zone, enter the zone number and select **RST.**

Browser Feature

If you are unsure of the zone number or description, refer to Appendix B at the back of this guide for a diagram showing you how to use the built-in **Bypass Zones browser.**

Zone Monitor

Allows the system to monitor selected disarmed zones (doors, windows, or motion detectors) and display their name at the keypad as they are faulted. This feature could be used to monitor an access door.

Zone Monitor works with any disarmed zone and will also sound the keypad monitor tone when the zone faults. The zone name is displayed at all keypads in your system.

You can place any combination of disarmed zones in Zone Monitor but only the most recent zone faulted is displayed. The displayed zone name clears automatically after a short time or when the zone is armed.

Using Zone Monitor as part of your weekly system test: After using the System Test function, place all zones in Zone Monitor. Starting at the front door, go around and open and then close each door and window. You should hear the keypad beep each time. The keypad will also display the name of each zone as its device is opened.

Once all protected doors and windows have been tested, walk in front of each motion detector. The keypad should beep to confirm their operation. If at any time during your weekly testing a device does not cause the keypad to beep, call the service department for assistance.

Using the Zone Monitor Function

1. Access the User Menu.
2. Press COMMAND until **ZONE MONITOR?** displays.
3. Press any Select key. The keypad displays **ALL NBR**.
4. Select **ALL** to place all disarmed zones into Zone Monitor.
 - 4a. The keypad displays **ALL? ADD RMV**.
 - 4b. Select **ADD** to add all disarmed zones to Zone Monitor.
 - 4c. Select **RMV** to remove all disarmed zones.
5. Select **NBR** to enter a specific zone number for zone monitor.
6. If **NBR** is selected, the keypad displays **ZONE: - ADD RMV**.
 - 6a. Enter any zone number and select **ADD** to add this zone.
 - 6b. Enter any zone number and select **RMV** to remove this zone.
7. The zone number automatically disappears and a new zone number can then be entered in step 6a or 6b.

Browser Feature

If you are unsure of the zone number or description, refer to Appendix B at the back of this guide for a diagram showing you how to use the built-in **Zone Monitor browser**.

System Status

Displays the current condition of internal system hardware.

System Status displays the condition of the panel's AC power, battery power, and optional panel tamper. When System Status is selected, each monitor is displayed followed by **OKAY** or **TRBL** (Trouble) to indicate the current condition.

Using the System Status Function

1. Access the User Menu.
2. Press COMMAND until **SYSTEM STATUS?** displays.
3. Press any Select key. The display starts listing each system monitor and status.

For example: **AC POWER - OKAY**

Below are the System Monitor displays:

Keypad Display	What it monitors
AC POWER	= AC power
BATTERY	= Battery power
TAMPER	= Panel box tamper

These are followed by either **OKAY** or **TRBL** (trouble).

If **TRBL** is displayed, call the service department for assistance.

4. The system then displays its firmware version (for example, **VER_201_9/15/99**), the panel model (**MODEL XR200-485**), and then exits the User Menu.

System Test

System Test is used to test the battery, alarm bell or siren, and communication to a central station. The System Test function begins automatically as soon as you select it.

Using the System Test Function

1. Access the User Menu.
2. Press COMMAND until **SYSTEM TEST?** displays.
3. Press any Select key. The system test begins automatically and the keypad displays the following messages in this order:
 - 1) **BELL SOUNDING** during a two second bell test
 - 2) **BATTERY - OKAY** or **BATTERY - TRBL** to indicate the condition of the battery
 - * 3) **TRANSMIT TEST** and **ATTEMPT NO : 1** during the transmit test
 - 4) **TRANSMIT OKAY** or **TRANSMIT FAILED** to show the results of the transmit test
 - 5) **TEST END** to indicate the System Test is complete.
 - 6) You can end the transmit test by pressing the Back Arrow key.

* The transmit test does not operate on local systems.

Testing your system's burglary protection: The System Test function should be a part of your weekly testing and should be followed by placing the interior and perimeter burglary devices in Zone Monitor mode. This allows you to open and then close each protected door and window while listening for the keypad to beep confirming its operation. See Zone Monitor.

XR200-485B Panic Test

Your system may be a Model XR200-485B which includes a panic button zone test. See the XR200-485B User's Guide Supplement section in the back of this guide.

User Profiles

This option allows you to add, delete, or change User Profiles. A profile defines the authority of each user code in the system. There are several characteristics associated with each User Profile that define its authority within the system.

Profile Number - Each profile may be assigned a unique number from 1 to 99. The Profile Number is the default Profile Name.

Profile Name - Each profile may be assigned a 16 character name. The Profile Number is used as the Default name.

Area Number - Each profile may be assigned specific areas of the burglary part of the system for arming and disarming. When profiles 1 to 98 are created, NO areas are assigned by default and the default for profile 99 is ALL areas assigned. Profile 99 is already added to the system by the factory.

Access Area Number - Each profile may be assigned door access area assignments. Default for profile 1 to 98 is NO areas assigned and default for profile 99 is ALL areas assigned. Profile 99 is already added to the system by the factory.

Output Group Assignment - Each profile may be assigned an output group number from 1 to 10. Default for profile 1 to 98 is NO output group assigned and default for profile 99 is output group **ten**. Your system may be programmed to turn on an output group at certain keypads when a door access occurs.

User Menu Assignments - Each user profile may have any of the menus assigned to it as shown in the Profile table on page 21. For explanations of User Menu Assignments, read the descriptions in the pages that follow. The Profile table lists the user menu profile assignments and the system functions users are allowed to access based on the profile numbers assigned to their codes. The settings listed in the table are default values and any of the profiles can be changed.

When adding or changing a profile, only selections that your code has authority to modify are shown.

Always make sure that at least one administrator code in your system has a profile with **all** authorities.

Adding User Profiles

1. Access the User Menu.
2. Press **COMMAND** until **USER PROFILES?** displays.
3. Press any Select key. The keypad displays **ADD DEL CHG**.
4. Press the first Select key, under **ADD**, to add a new user profile.
5. At the **PROFILE NO:** - prompt, enter an unused profile number and press **COMMAND**. The display changes to **PROFILE NAME**.
6. Press any Select key and the display changes to -. Enter a profile name of up to 16 characters. After the name is entered, press **COMMAND**. See **Entering Names** in Appendix B.
7. At the **AREAS:** prompt, enter the area numbers (1-8) for arming and disarming assigned to this profile.
8. The keypad displays **ACCESS:** . Enter the area numbers (1-8) assignment to allow door access for this profile. Press the **COMMAND** key.
9. The keypad displays **OUTPUT GROUP:** -. Enter the number (1-10) for the Output Group assigned to this profile. Press the **COMMAND** key.
10. The keypad displays each of the menus as shown in the Profile Table on the following page for you to enable for this profile number. Select **YES** or **NO** and press the **COMMAND** key to advance to the next menu Selection.
11. When you have completed Selecting all User Profile menu assignments, the keypad displays **PROFILE ## ADDED** message for 4 seconds.

User Profiles Chart

				Profiles												
			Number													
Menu		Privilege		1	2	3	4	5	6	7	8	9	10	11-98	99	
ARM/DIS	NO	YES	Arm and Disarm	No	Yes	Yes	Yes	Yes	Yes	Yes	Yes	Yes	Yes	No	No	Yes
ALM SLNC	NO	YES	Alarm Silence	No	Yes	Yes	Yes	Yes	Yes	Yes	Yes	Yes	Yes	No	No	Yes
SNSR RST	NO	YES	Sensor Reset	Yes	Yes	Yes	Yes	Yes	Yes	Yes	Yes	Yes	Yes	No	No	Yes
DOOR ACS	NO	YES	Door Access	Yes	Yes	Yes	Yes	Yes	Yes	Yes	Yes	Yes	Yes	Yes	No	Yes
ARM AREA	NO	YES	Armed Areas	Yes	Yes	Yes	Yes	Yes	Yes	Yes	Yes	Yes	Yes	No	No	Yes
OUTPUTS	NO	YES	Outputs ON/OFF	No	No	No	No	Yes	Yes	Yes	Yes	Yes	Yes	No	No	Yes
ZN STATS	NO	YES	Zone Status	Yes	Yes	Yes	Yes	Yes	Yes	Yes	Yes	Yes	Yes	No	No	Yes
BYPAS ZN	NO	YES	Bypass Zones	No	No	No	No	No	Yes	Yes	Yes	Yes	Yes	No	No	Yes
ZONE MON	NO	YES	Zone Monitor	No	No	No	Yes	Yes	Yes	Yes	Yes	Yes	Yes	No	No	Yes
SYS STAT	NO	YES	System Status	Yes	Yes	Yes	Yes	Yes	Yes	Yes	Yes	Yes	Yes	No	No	Yes
SYS TEST	NO	YES	System Test	No	No	No	Yes	Yes	No	Yes	Yes	Yes	Yes	No	No	Yes
PROFILES	NO	YES	User Profiles	No	No	No	No	No	No	No	No	Yes	No	No	No	Yes
USR CODE	NO	YES	User Codes	No	No	No	No	No	No	No	No	Yes	No	No	No	Yes
SCHEDULS	NO	YES	Schedules	No	No	No	No	No	No	Yes	Yes	Yes	Yes	No	No	Yes
TIME	NO	YES	Time	No	No	No	No	No	No	No	Yes	Yes	Yes	No	No	Yes
DIS EVNT	NO	YES	Display Events	Yes	Yes	Yes	Yes	Yes	Yes	Yes	Yes	Yes	Yes	No	No	Yes
SERV REQ	NO	YES	Service Request	No	No	No	No	No	No	No	Yes	Yes	Yes	No	No	Yes
FIRE DRIL	NO	YES	Fire Drill	No	No	No	No	No	No	No	Yes	Yes	Yes	No	No	Yes
EXTEND	NO	YES	Extended Schedules	No	No	No	No	No	Yes	Yes	Yes	Yes	Yes	No	No	Yes
TEMP CODE	NO	YES	Temporary User Code	No	No	No	No	No	No	No	No	No	No	No	No	No
ANTI PASS	NO	YES	Antipass Back	No	No	No	No	No	No	No	No	No	No	No	No	No
ALOW: 1234	__	ANY	Alow: Shift/Time Access	1234	1234	Any	Any	Any	Any	Any	Any	Any	Any	Any	Any	Any

Deleting User Profiles

1. Access the User Menu.
2. Press COMMAND until **USER PROFILES?** displays.
3. Press any Select key. The keypad displays **ADD DEL CHG**.
4. Press the second Select key, under **DEL**, to delete a user profile.
5. At the **PROFILE NO:** - prompt, enter a profile number and press COMMAND. The display changes to **DELTD**.

Note: User codes assigned to deleted profiles will not function.

Changing User Profiles

1. Access the User Menu.
2. Press COMMAND until **USER PROFILES?** displays.
3. Press any Select key. The keypad displays **ADD DEL CHG**.
4. Press the far right Select key, under **CHG**.
4. At the **PROFILE NO:** - prompt, enter a profile number and press COMMAND. The display changes to **PROFILE NAME**.
5. Press any Select key and the display changes to -. Enter a profile name of up to 16 characters. The default Profile Name uses the Profile Number. After the name is entered, press COMMAND.
6. At the **AREAS:** prompt, enter the area numbers (1-8) for arming and disarming assigned to this profile.
7. The keypad displays **ACCESS:** . Enter the area numbers (1-8) assignment to allow door access for this profile. Press the COMMAND key.
8. The keypad displays **OUTPUT GROUP:** -. Enter the number (1 through 10) for the Output Group assigned to this profile. Press the COMMAND key.

9. The keypad displays each of the menus as shown in the Profile Table for you to enable for this profile number. Select **YES** or **NO** and press the COMMAND key to advance to the next menu Selection.
10. When you have completed Selecting all User Profile menu assignments as shown in the Profile table, the keypad displays **PROFILE CHNGD** message for 4 seconds, indicating the profile is changed.

TEMP CODE

When **YES** is selected for this menu option, and when this profile is assigned to a user code (see next section), the keypad will display **TEMP DAYS:** . Enter the number of days (1 to 250) that a temporary User Code can operate. Default is 7 days. Temp users are deleted from the system at 12:00 AM on the last day.

ALLOW: 1 2 3 4 ANY

This menu option defines the time schedules that the User Code will operate for door access and disarming. Selecting **1, 2, 3, and/or 4** indicates operation during the S1-S4 shift schedules. Selecting **ANY** (fourth Select key) from the menu indicates that the code will operate any time, regardless of schedules. All shift schedules may be selected for one user. Menu access is not affected by this option.

An **UNAUTHORIZED ENTRY** message is sent to the central station if disarming occurs outside the open/close schedule for any of the areas.

Browser Feature

Refer to Appendix B at the back of this guide for a diagram showing you how to use the **Output Group browser and the Profile browsers**.

User Codes

This option allows you to add, delete, or change a user code. You may also assign specific User Profiles to individual users.

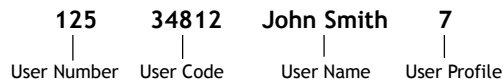

User Number - Every user is numbered. This number identifies the user to the system and is transmitted to the central station when the user arms or disarms areas.

User Code - Each user also has a 3 to 5 digit number to enter into the Security Command keypad when arming or disarming the system. **Note:** A User Code cannot begin with zero and 3-digit codes cannot begin with 98.

User Names - Each code may also be programmed with the user's name. Up to 16 characters may be entered.

User Profile - The user is also assigned a Profile (1 to 99) by the person administrating the system that determines the areas and functions the user can access.

Adding User Codes

1. Access the User Menu.
2. Press COMMAND until **USER CODES?** displays.
3. Press any Select key. The keypad displays **ADD DEL CHG BAT**.
4. Press the Select key under **ADD** or **BAT** (Batch) to add a new user code.

5. At the **USER NUMBER:** - prompt, enter a user number and press **COMMAND**. The display changes to **CODE NO:** - .
6. Enter a user code of 3 to 5 digits and press **COMMAND**. The user enters this number to arm, disarm, etc. If using access cards, present the card instead of entering a code. After the code is entered the keypad displays **USER NUMBER ###** as the user name.
7. A 16-character name may be entered to identify the user. Press any top row key to clear the current name. You may then enter the new name. After the name is entered press **COMMAND**. See **Entering Names** in Appendix B.
8. The display changes to **PROFILE NO:** -. Select the profile number to assign a set of authorized functions to the user code as outlined in the **Profile Table** on the previous page.
9. At the **PROFILE NO:** - display, enter a profile number from 1 to 99, and press **COMMAND**. The displays shows **USER # ADDED**.

If **BAT** (Batch) has been chosen in step 4 instead of **ADD**, the next available user number will be automatically selected and steps 6 and 7 only will be repeated. The User Profile assignment will be automatically selected for the next user based on the previous user entered. This batch entry method speeds up user entry in large systems.

Browser Feature

Refer to Appendix B at the back of this guide for a diagram showing you how to use the **User Profiles Change browser**.

Deleting User Codes

1. Access the User Menu.
2. Press **COMMAND** until **USER CODES?** displays.
3. Press any Select key. The keypad displays **ADD DEL CHG BAT**.
4. Press the second Select key, under **DEL**, to delete a user code from the system. To delete a user code, you must have a user code with a profile that has user code authority.

Note: Your system must have at least one user with user code authority in order to be able to add or delete user codes. Be careful not to delete all users with user code authority from your system. Also, the user code used to enter the user menu to delete codes cannot be deleted. In other words, you can not delete yourself.

5. At the **USER NUMBER:** - prompt, enter the user number you want to delete and press **COMMAND**. The display changes to **USER # DELETED**.
6. The display then changes back to **USER NUMBER:** - allowing you to delete another user. Press the Back Arrow key twice to exit the User Menu.

Changing User Codes

1. Access the User Menu.
2. Press the **COMMAND** key until **USER CODES?** displays.
3. Press any Select key. The keypad displays **ADD DEL CHG BAT**.
4. Press the third Select key, under **CHG**, to change a user code.
5. At the **USER NUMBER:** - prompt, enter the user number to change and press **COMMAND**.

Refer to the System Setup section for the number of user codes available for your system.

6. The display changes to **CODE NO: * * * * ***. Press a Select key and enter the new user code. Press **COMMAND**.
7. The display then shows the current user name. Press any top row key to clear. See **Entering Names** in Appendix B to enter a new name.

Note: Changing a user code does not change the user number.

8. The display changes to **PROFILE NO: -**. Select the profile number to assign a set of authorized functions to the user code as outlined in the **Profile Table** on page 11.
9. After entering the profile number, the keypad displays **USER # CHANGED** for 5 seconds followed by **USER NUMBER: -**. This display allows you to enter another user number to change. Press the Back Arrow key twice to exit the User Menu.

Browser Feature

Refer to Appendix B at the back of this guide for diagram showing you how to use the **User Codes Add, Delete, and Change browsers**.

Forgive Failure to Exit

Failure to Exit is an Anti-pass back violation in which a user assigned with anti-pass back has attempted to re-enter an area that the user did not exit through.

Forgive Failure to Exit removes the anti-pass back violation. See page 5 for more information about anti-pass back.

1. After the **USER CODES?** menu has been accessed and **ADD DEL CHG BAT** is displayed, press **COMMAND**. The keypad displays **FRGV**.
2. Press the top left key. The display changes to **USER NUMBER:-**
3. At the **USER NUMBER:-** prompt, enter the user number to be forgiven and press **COMMAND**. The User Code Browser described in the Appendix can help find the appropriate user by name if you do not know the number.
4. To clear the **FAILURE TO EXIT** (Anti-pass back) violation for all users enter **000** at the **USER NUMBER:-** prompt.
5. The keypad will display **USER XXX FORGIVE** to confirm, then return to step 3 for the next user. Press the Back Arrow key to exit this menu.

Ambush Codes

Your system may be programmed to allow user number 1 to be an Ambush code. This Ambush code functions identically to a standard code with the exception that it sends a silent alarm to the central station. This silent alarm alerts the operator to a duress situation at the premises and prompts the immediate notification of authorities.

Refer to the System Setup section of this guide to see if your system is programmed for Ambush. If so, do NOT program a code for user number 1 unless you intend to use the Ambush function.

Schedules

Schedules are ideal for auto arming and disarming of individual areas and for creating Opening/Closing windows during which users can access the building or disarm the system. Having separate schedules allows you to create Opening/Closing windows for each day. One could be for normal business activity and another could be for cleaning crews or a second shift. Once programmed, these schedules operate continually until changed.

The Schedules function allows you to program into the system the times at which you normally turn your burglary protection on and off each day of the week. This information can then be used by the system to automatically arm or disarm the burglary protection.

If your system does not use automatic arming, you can use the Closing Check/Extend feature with Schedules to help ensure your system is armed manually at a specific time. This option sounds the keypad buzzer and displays **CLOSING TIME!** or **AREA LATE!** when a schedule expires. Users still on the premises are reminded to arm the system or extend the schedule to a later time.

Your system provides you with five different types of schedules:

Shift (S1, S2, S3, S4) allow you to set access and disarm schedules that occur at the same time each day until you change them. Users are assigned to shifts using the **ALLOW** authority.

Output (OUT) schedules allow you to set the times when relay outputs or door strikes connected to your system turn ON and OFF automatically.

Door (DOOR) schedules allow you to set times when door strikes turn ON and OFF automatically.

Holiday (HOL) dates allow you to enter special dates which activate Holiday Schedules that supercede all other schedules.

Extend (EXT) schedules allow you to set a time for a one time extend of the current running shift (S1 - S4) schedule.

Setting Shift (S1 S2 S3 S4) Schedules

1. Access the User Menu and press **COMMAND** until **SCHEDULES?** displays. Press any **Select** key.
2. The keypad displays **S1 S2 S3 S4**. Press the **Select** key under the shift you want to program. This will allow you to enter a schedule that remains in place until you change or delete it.
3. Your system may be programmed to allow four shift schedules per area, if so, **AREA NO:-** is displayed. Enter the area number that you are assigning to a schedule. Press the **COMMAND** key to accept your Selection and continue setting schedules.
4. The keypad displays **SUN MON TUE WED**. Press the **COMMAND** key to display **THU FRI SAT HOL**. Press the **Select** key under the day you want the schedule to begin. If **HOL** is selected, go to **Setting Holiday ABC Schedules** for additional instructions.
Note: After Selecting the day of the week or holiday for the schedule to begin, the keypad displays any currently programmed Opening and Closing times previously set for that day. This feature allows you to review programmed schedules at any time.
A schedule entered in **HOL** (holiday) will be active and override **SUN MON TUE** etc. schedules anytime a holiday date occurs.
5. If Opening and Closing times are displayed, the keypad then displays **DELETE KEEP**. Press the **Select** key under **DELETE** to enter new times.

6. The keypad then displays **OPENING TIME?** followed by the display **MON - : AM PM**. Enter the new opening time and select **AM** or **PM**.
Enter all schedule times using a 12 hour clock. For example, to enter 6 AM you would enter a 0 + 6 + 0 + 0 and press the **Select** key under **AM**. For 11 PM you would enter a 1 + 1 + 0 + 0 and press the **Select** key under **PM**.
The keypad then displays **CLOSING TIME?** followed by the display **MON - : AM PM**. Enter the new closing time and select **AM** or **PM**. Pressing the **Select** key under the day **MON** (whichever day is displayed) allows you to scroll through the days of the week and create a schedule window that spans multiple days.
Note: You must enter an Opening *and* Closing time or the system will not recognize the schedule.
The new schedule is now part of your system.
7. The keypad goes back to the **SUN MON TUE WED** display allowing you to enter another schedule.
8. To **clear** a schedule press **DELETE** and then **AM** when the opening time is requested.
Press the **Back Arrow** key to exit the User Menu.

Setting Output (OUT) and Door (DOOR) Schedules

The Schedules function allows you to set up to 100 different scheduled times for relay outputs and door access relays connected to your system to turn ON and OFF automatically. The maximum number of schedules that can be assigned per door access relay or relay output is 8.

1. Access the User Menu.
2. Press COMMAND until **SCHEDULES?** displays.
3. After you have accessed the **SCHEDULES?** menu and the schedule options, **S1 S2 S3 S4**, have been displayed, press the COMMAND key once more and the display will change to **OUT DOOR HOL EXT**. Press the Select key under **OUT** or **DOOR**.
4. At the **OUTPUT NO: -** or **DOOR NO: -** display, enter the output number you want to program. Press the COMMAND key.

If adding a schedule and all 100 are currently in use, you will get an **OUT SCHEDS FULL** display. You must then delete an existing schedule.

5. The keypad displays **SCHEDULE NO: -**. Enter the schedule number (1 to 8) and press the COMMAND key.
6. The keypad displays **SUN MON TUE WED**. Press the COMMAND key to display **THU FRI SAT HOL**.
7. Press the Select key under the day you want to program. If you select **HOL** go to **Setting Holiday ABC Schedules** for more information.

Note: After Selecting the day of the week for the schedule to occur, the keypad displays any currently programmed ON OFF times previously set for that day. This feature allows you to review programmed schedules at any time.

8. If ON OFF times are displayed, the keypad then displays **DELETE KEEP**. Press the Select key under **DELETE** to enter new times.
9. The keypad then displays **ON TIME?**. This is followed by the display - : **AM PM**.
Enter a new relay ON time and Select **AM** or **PM**.
The display changes to **OFF TIME?**. This is followed by the display - : **AM PM**.
Enter a new OFF time for the relay.
Enter all schedule times using a 12 hour clock. For example, to enter 6 AM you would enter a 0 + 6 + 0 + 0 and press the Select key under **AM**. For 11 PM you would enter a 1 + 1 + 0 + 0 and press the Select key under **PM**.
10. The keypad returns to the day of the week display allowing you to enter another Output or Door schedule. To exit the user menu or to go back to the **S1 S2 S3 S4** display, press the Back Arrow key.
11. To **clear** a schedule press **DELETE** and then **AM** when the opening time is requested.

Setting Holiday ABC Schedules for S1, S2, S3, S4, OUT, and DOOR Schedules

Three Holiday schedules are available for each shift (S1, S2, S3, S4), each output relay (OUT), each door access relay (DOOR), and are available through their respective menu options. This allows a shift, output, or door to have three different schedules for holidays. For example, Holiday Schedule A for those holidays when the building stays closed, Holiday Schedule B for a day that only opens for a morning, etc. Also, Holiday Schedules can be used to cross multiple days. These schedules become active and supercede the current days schedule when a Holiday Date occurs. See **Setting Holiday Dates (HOL)**.

1. After you have accessed the **SCHEDULES?** menu and the schedule options, **S1 S2 S3 S4**, have been displayed, press the **COMMAND** key until the display changes to **SUN MON TUE WED**. Press the **COMMAND** key again to display **THU FRI SAT HOL**.
2. Press the **Select** key under **HOL**.
3. The keypad displays **HOL: A B C**. Press the **Select** key under **A** to set the first of three holiday schedules.
4. The keypad displays **A - : AM PM**.

Note: After Selecting the schedule, the keypad displays any current times previously set for that holiday. This feature allows you to review the programmed times.

5. If times are displayed, the keypad then displays **DELETE KEEP**. Press the **Select** key under **DELETE** to enter new times.
6. The keypad then displays **ON TIME? or OPENING TIME?**. This is followed by the display - : **AM PM**.
Enter a new time and select **AM** or **PM**.
The display changes to **OFF TIME? or CLOSING TIME?**. This is followed by the display - : **AM PM**.
Enter a new time.
Enter all schedule times using a 12 hour clock. For example, to enter 6 AM you would enter a 0 + 6 + 0 + 0 and press the **Select** key under **AM**. For 11 PM you would enter a 1 + 1 + 0 + 0 and press the **Select** key under **PM**.
7. The keypad returns to **HOL: A B C** allowing you to enter a **B** and/or **C** holiday schedule for the same shift (S1, S2, S3, or S4), Output or Door. Go back to step 3 to add additional holiday schedules.
8. To exit the user menu or to go back to the **S1 S2 S3 S4** display, press the **Back Arrow** key. To **clear** a schedule press **DELETE** and then **AM** when the opening time is requested.

Setting Holiday Dates (HOL)

Setting Holiday Dates provides the system with dates in the year that the normal opening and closing schedules are not used and are superceded by one of the Holiday Schedules A or B or C. When the panel determines that it is a holiday, the Holiday Schedule supercede the current schedule for that day. Up to twenty different holiday dates can be entered.

1. After you have accessed the **SCHEDULES?** menu and the schedule options, **S1 S2 S3 S4**, have been displayed, press the **COMMAND** key once more and the display will change to **OUT DOOR HOL EXT**. Press the Select key under **HOL** to program Holiday dates.
2. The keypad display changes to **HOL: xx mm/dd A**. You can now enter the month and day for the first holiday. Press the Select key under **A** to change to **HOL B**. Pressing again changes to **HOL C**. **Example:** July fourth would be entered by pressing the 0704 keys. The keypad will display **HOL:1 07/04 B**.
3. To step to the next holiday number, press **COMMAND**. To clear a holiday press any top row key when the appropriate holiday number is displayed. Press the Back Arrow key when **HOL: 1** or the **COMMAND** key when **HOL: 20** is displayed to exit the menu.

Note: The Holiday Dates entered indicate the days of the year when the **HOL** schedules will be used. When entering holiday dates that are used for door or output holiday schedules, the date must be entered as a holiday date for all partitions that are available. For information on setting holiday schedules for Shift, Output, and Door, see **Setting Holiday ABC Schedules**.

Extending Schedules (EXT)

Extending schedules (**EXT**) allows the Closing Check operation to be delayed until the new closing time expires. This allows the current shift schedule to ignore its closing time and not send a **LATE TO CLOSE** message to the central station. This function is designed to allow workers to stay later and does not extend door access authority. The extended schedule is erased when it expires.

1. After you have accessed the **SCHEDULES?** menu and the schedule options, **S1 S2 S3 S4**, have been displayed, press the **COMMAND** key once more and the display will change to **OUT DOOR HOL EXT**. Press the Select key under **EXT** to program Extended Schedules.
2. The keypad displays - : **AM PM**. Enter a time to extend the current Closing Check open period. Press **COMMAND** to exit the menu.

A shift may be extended up to 23 hours and 59 minutes from the time the extend function is performed.

To extend the system's schedule after the closing time has been reached:

1. Press any Select key. The keypad will display **ENTER CODE:-**.
2. Enter your code and press **COMMAND**. The system's schedule is automatically extended one hour.
3. The keypad then displays - : **AM PM**. You can enter a time to extend the schedule for greater than one hour. Press **AM** or **PM**.

Note: If the system is not armed by the scheduled closing time, a Late to Close report is sent to the central station. If the schedule is extended, a Schedule Change report is sent to the central station.

Setting the Date and Time

Allows you to change the current date and time displayed on the Security Command keypad and used by the system.

Setting the System's Date and Time

1. Access the User Menu.
2. Press **COMMAND** until **TIME?** displays. Press any Select key.
3. The keypad displays the current day and time. Press the **COMMAND** key. The keypad displays the current date. Press the **COMMAND** key to make any changes.
4. The keypad displays **TIME DAY DATE**.
5. Press the Select key under **TIME** to change the time. The keypad displays - : **AM PM**. Enter the current time and select **AM** or **PM**. The display changes back to **TIME DAY DATE**.
6. Press the Select key under **DAY** to change the day of week. The keypad displays **SUN MON TUE WED**. If the current day of the week is not displayed, press the **COMMAND** key.
7. The keypad displays **THU FRI SAT**. Press the Select key under the correct day. You can use the Back Arrow key to toggle between the two day of the week displays.
8. Press the Select key under **DATE** to change the date. The keypad displays
MONTH:- Enter one or two digits for the month.
Press **COMMAND**.
DAY:- Enter up to two digits for the day.
Press **COMMAND**.
YEAR:- Enter up to two digits for the year.
Press **COMMAND**.

The display returns to the **TIME DAY DATE** display.

Press the Back Arrow key to exit the User Menu.

Display Events

Allows you to review up to 1000 past door accesses and 200 past system events. There are six event types:

Zone Activity - Zone alarms, troubles, and restorals.

Opening and Closing - Arming and disarming of the system.

User Code - Adding, deleting, and changing user codes.

Schedule Changes - Adding, deleting, and changing schedules.

Door Access - Each door access function used at a keypad.

Supervisory - Problems with the system's hardware components.

The system's memory holds a maximum of 1000 past door access events and 200 system events for 45 days. Any event older than 45 days is cleared automatically by the system. Also, once the full 1200 events are stored, any new event causes the oldest event to be cleared. See Appendix A for Display Events.

Using the Display Events

1. Access the User Menu.
2. Press the **COMMAND** key until **DISPLAY EVENTS?** displays. Press any Select key.
3. The keypad displays **FRST LST PRT SRT**. Select **FRST** (first) to view the oldest to newest events. Select **LST** (last) to view the newest to oldest events. If you select **FIRST**, use the **COMMAND** key to scroll up through the events. If you select **LAST**, use the Back Arrow key to scroll down through the events.
Select **SRT** to sort through the Display Events log and collect information specific to a user or system event.
Select **PRT** to print the complete Display Events log.
4. To use the Sort feature, press the Select key under **SRT**. The keypad displays **FRST DATE: 8/21**. Press any Select key and enter a 4-digit beginning date for the sort. Press **COMMAND**.
5. The keypad displays **LAST DATE: 10/17**. Press any Select key and enter a 4-digit ending date for the sort. Press **COMMAND**.
6. The keypad displays **USER NUMBER: -**. To sort events for a particular user, enter their user number or press **COMMAND** to sort for all users. To search for a user, press any Select key then use the **COMMAND** and Back Arrow keys to browse through the user names in the system. When the user you want is displayed, press any Select key then press **COMMAND**.

7. The keypad next displays five event types that you can include in the sort. Press the fourth Select key to display **YES** as the event type name is displayed on the keypad. Press **COMMAND**. The following are the five sort event types:

ACCESSES = door accesses granted.

DOOR NUMBER = leave blank for all doors.

Note: If accesses is selected **YES** then only Door Access Granted Events will be included in the sort.

ZONE EVENTS = zone alarms, troubles, and restorals.

ARM/DISARM = arming and disarming events.

USER EVENTS = adding, deleting, and changing user codes.

SUPERVISORY = system hardware problems and door access denied events.

8. After the last event type is displayed, the keypad again displays **FRST LST PRT SRT**. You can now view or print the new sorted Display Events or press **SRT** for a new sort.

Service Request

Your user code profile may be programmed for Service Request. This feature of the User Menu allows you to just press any top row Select key while **SERVICE REQUEST?** is displayed and have the system automatically send a "Request for Service" message to the central station. The display changes to **REQUEST MADE** momentarily to confirm your request was sent.

Fire Drill

Fire Drill is used to test the fire bells or fire horns in your system. The Fire Drill test turns on your system bell circuit, but does not send a message to the central station.

Starting a Fire Drill test

1. Access the User Menu.
2. Press **COMMAND** until the **FIRE DRILL?** displays. Press any Select key.
3. The keypad displays **SURE? YES NO**.
4. Press the Select key under **YES** to start the Fire Drill test.

Ending a Fire Drill test

1. Enter your code at the keypad and press **COMMAND** to end the Fire Drill.
2. The Fire Drill test will automatically end with an **ALARM SILENCE** or the programmed **Bell Cutoff** time.

XR200-485B User's Guide Supplement

This supplement is intended for use with the XR200-485B Access Control Interface Card and includes information about the additional features specific to the 485B.

Two Man Rule

During an entry delay time, the keypad displays **ENTER CODE:**. If areas of your system are programmed for Two Man Rule, anytime a user enters a code to disarm a Two Man area or perform a door access, the keypad displays **2ND CODE:** - for 10 seconds. A second and different user code must be entered within that 10-second period. If you enter a second code that is the same as the first code, the keypad displays **INVALID CODE**. If you enter a second code that does not have the equivalent authorization as the first code, the keypad displays **TRY AGAIN**. If you do not enter the second code within the 10-second period, the display returns to normal.

Early Morning Ambush

If your system is programmed for Early Morning Ambush, when an area is disarmed by a user code, an Ambush message will be sent to the central station unless you enter a second user code. This message is delayed by a programmed number of minutes to allow time for you to inspect the premises for intruders. (See the System Setup on the next page for the amount of time programmed for the Early Morning Ambush delay.) The second user code can be the same code or a different code entered from the Status List in the disarm menu. If the second user code is not entered before the Early Morning Ambush delay expires, a silent Ambush message is sent to the central station. The second user code must have authority to cancel the Early Morning Ambush operation.

System and Panic Zones Test

System Test is used to test the system including battery, alarm bell or siren, and communication to a central station. Also, system test is used to test user panic zones. This allows you to test panic buttons for operation without sending a message to the central station. The System Test or Panic Zone Test function begins automatically as soon as you select it.

Using the System Test

1. Access the User Menu.
2. Press **COMMAND** until **SYSTEM TEST?** displays.
3. Press any Select key. The keypad displays **SYSTEM PANICS**.
4. Press the Select key below **SYSTEM**.
5. The System Test begins automatically. The keypad displays:
 - a) **BELL SOUNDING** during a two second bell test
 - b) **BATTERY - OKAY** or **BATTERY - TRBL** to indicate the condition of the battery
 - * c) **TRANSMIT TEST** and **ATTEMPT NO : 1** during the transmit test
 - d) **TRANSMIT OKAY** or **TRANSMIT FAILED** to show the results of the transmit test
 - e) **TEST END** to indicate the System Test is complete.
 - f) You can end the transmit test by pressing the Back Arrow key.

* The transmit test does not operate on local systems.

Using the Panic Zone Test

1. Access the User Menu.
2. Press COMMAND until **SYSTEM TEST?** displays.
3. Press any Select key. The keypad displays **SYSTEM PANICS**.
4. Press the Select key below **PANICS**.
5. The Panic Zone Test begins automatically and the keypad displays **TRIPS: END**.

During the Panic Zone Test, trip each panic zone (or button) on the system by pressing and holding the panic for 1 to 2 seconds.

Note: You do **NOT** have to hold the panic for 2 seconds in normal mode. You are only required to hold the panic during the Panic Zone Test because the zone takes a little extra time to report when the system is in test mode.

Each time you trip a panic zone, the display number increments and the keypad buzzer sounds for two seconds.

The number of panic zones tripped is constantly displayed until the test is ended or no panic zone activity has occurred for 20 minutes.

6. Press the Select key below **END** to stop the Panic Zone Test.
7. **PANIC TEST OKAY** is displayed when the Panic Zone Test is completed and all zones tested OK.
8. When the Panic Zone Test ends and a zone failed (did not trip) during the test, the keypad displays the zone name and number and the buzzer sounds for one second. Press the COMMAND key to display the next failed zone.

Note: During the Panic Zone Test, any zones that fail are not sent to the receiver or to the pager.

Testing your system's burglary protection

The System Test function should be a part of your weekly testing and should be followed by placing the burglary devices in Zone Monitor mode. This allows you to open and then close each protected door and window while listening for the keypad to beep confirming its operation. See Zone Monitor.

Bank Safe & Vault

Areas of your system may be programmed for Bank Safe & Vault to prevent anyone from disarming an area outside of its scheduled open period. Any zones in the area cannot be bypassed or force armed at arming. This operation provides added security to safe and vault areas of your system. Also, zones assigned to bank safe and vault areas may not be bypassed at arming.

System Setup

System Setup Record

We have provided this System Setup section to allow you to track the current and future status of the programmable options on your Security Command system. If you make changes to the system, you should update the information contained on these pages.

Your system is monitored by a central station.

Yes No

C/S Name: _____

Address: _____

City/State: _____

Emergency Phone: _____

Service Phone: _____

Service Manager: _____

Your system sends Opening and Closing reports.

Yes No

Your system sends Zone Bypass reports.

Yes No

Your system sends Ambush reports.

Yes No

485B System Setup Record

This section allows you to track the status of the XR200-485B programmable options on your Security Command system.

Your system is programmed for Two Man Rule and requires a second user code to be entered when disarming an area, or for door access.

Yes No

Your system is programmed for Early Morning Ambush and requires a second user code to be entered to prevent an Ambush message from being sent to the central station.

Yes No

Amount of time to enter second user code for the Early Morning Ambush delay:

Early Morning Ambush delay _____ minutes.

Your area # ____ is programmed for Bank Safe & Vault to prevent anyone from disarming outside of the scheduled open period.

Yes No

Security Command Keypad Record

Device #	Name	Area
1	_____	1 2 3 4 5 6 7 8
2	_____	1 2 3 4 5 6 7 8
3	_____	1 2 3 4 5 6 7 8
4	_____	1 2 3 4 5 6 7 8
5	_____	1 2 3 4 5 6 7 8
6	_____	1 2 3 4 5 6 7 8
7	_____	1 2 3 4 5 6 7 8
8	_____	1 2 3 4 5 6 7 8
9	_____	1 2 3 4 5 6 7 8
10	_____	1 2 3 4 5 6 7 8
11	_____	1 2 3 4 5 6 7 8
12	_____	1 2 3 4 5 6 7 8
13	_____	1 2 3 4 5 6 7 8
14	_____	1 2 3 4 5 6 7 8
15	_____	1 2 3 4 5 6 7 8
16	_____	1 2 3 4 5 6 7 8

Which keypads display System Status?

- 1 & 9 2 & 10 3 & 11 4 & 12 5 & 13
 6 & 14 7 & 15 8 & 16 N/A

Which keypads display Armed Status?

- 1 & 9 2 & 10 3 & 11 4 & 12 5 & 13
 6 & 14 7 & 15 8 & 16 N/A

Which keypads provide Door Access reports?

- 1 & 9 2 & 10 3 & 11 4 & 12 5 & 13
 6 & 14 7 & 15 8 & 16 N/A

Area Names and Numbers Record

Your system may be divided into eight separate areas, each area can have a name or description that displays at the keypad. This can help you easily track events when they occur elsewhere in your system.

Area

Name

1	_____
2	_____
3	_____
4	_____
5	_____
6	_____
7	_____
8	_____

Suggestion: Photocopy this page before using.

Suggestion: Photocopy this page before using.

Profile #	Profile Name	Arm/Disarm Area	Access Area	Output Group
_____	_____	1 2 3 4 5 6 7 8 1 2 3 4 5 6 7 8	_____	_____
_____	_____	1 2 3 4 5 6 7 8 1 2 3 4 5 6 7 8	_____	_____
_____	_____	1 2 3 4 5 6 7 8 1 2 3 4 5 6 7 8	_____	_____
_____	_____	1 2 3 4 5 6 7 8 1 2 3 4 5 6 7 8	_____	_____
_____	_____	1 2 3 4 5 6 7 8 1 2 3 4 5 6 7 8	_____	_____
_____	_____	1 2 3 4 5 6 7 8 1 2 3 4 5 6 7 8	_____	_____
_____	_____	1 2 3 4 5 6 7 8 1 2 3 4 5 6 7 8	_____	_____
_____	_____	1 2 3 4 5 6 7 8 1 2 3 4 5 6 7 8	_____	_____
_____	_____	1 2 3 4 5 6 7 8 1 2 3 4 5 6 7 8	_____	_____
_____	_____	1 2 3 4 5 6 7 8 1 2 3 4 5 6 7 8	_____	_____
_____	_____	1 2 3 4 5 6 7 8 1 2 3 4 5 6 7 8	_____	_____
_____	_____	1 2 3 4 5 6 7 8 1 2 3 4 5 6 7 8	_____	_____
_____	_____	1 2 3 4 5 6 7 8 1 2 3 4 5 6 7 8	_____	_____
_____	_____	1 2 3 4 5 6 7 8 1 2 3 4 5 6 7 8	_____	_____
_____	_____	1 2 3 4 5 6 7 8 1 2 3 4 5 6 7 8	_____	_____
_____	_____	1 2 3 4 5 6 7 8 1 2 3 4 5 6 7 8	_____	_____
_____	_____	1 2 3 4 5 6 7 8 1 2 3 4 5 6 7 8	_____	_____
_____	_____	1 2 3 4 5 6 7 8 1 2 3 4 5 6 7 8	_____	_____
_____	_____	1 2 3 4 5 6 7 8 1 2 3 4 5 6 7 8	_____	_____
_____	_____	1 2 3 4 5 6 7 8 1 2 3 4 5 6 7 8	_____	_____

Arm/Disarm	Alarm Silence	Sensor Reset	Door Access	Armed Areas	Outputs On/Off	Zone Status	Bypass Zones	Zone Monitor	System Status	System Test	User Profiles	User Codes	Schedules	Time	Display Events	Service Request	Fire Drill	Extend Schedules	Temp User Code	Anti-pass Back	Shift/Time Access	
																					1 2 3 4 A	
																						1 2 3 4 A
																						1 2 3 4 A
																						1 2 3 4 A
																						1 2 3 4 A
																						1 2 3 4 A
																						1 2 3 4 A
																						1 2 3 4 A
																						1 2 3 4 A
																						1 2 3 4 A
																						1 2 3 4 A
																						1 2 3 4 A
																						1 2 3 4 A
																						1 2 3 4 A
																						1 2 3 4 A
																						1 2 3 4 A
																						1 2 3 4 A
																						1 2 3 4 A

Suggestion: Photocopy this page before using.

User Codes Record

Depending on how your system is programmed, you may have 200 to 999 user codes available. As you add new users or change current users' codes, you can keep track of their profile number in the system. Use the following table to track custom user codes in your system.

User #	User Name	Profile #

User #	User Name	Profile #

Schedules Record

Schedule	Area Name	Status	SUN	MON	TUE	WED	THU	FRI	SAT	HOL A	HOL B	HOL C
S1 S2 S3 S4 Area #		Open	: _ M	: _ M	: _ M	: _ M	: _ M	: _ M	: _ M	: _ M	: _ M	: _ M
		Close	: _ M	: _ M	: _ M	: _ M	: _ M	: _ M	: _ M	: _ M	: _ M	: _ M
S1 S2 S3 S4 Area #		Open	: _ M	: _ M	: _ M	: _ M	: _ M	: _ M	: _ M	: _ M	: _ M	: _ M
		Close	: _ M	: _ M	: _ M	: _ M	: _ M	: _ M	: _ M	: _ M	: _ M	: _ M
S1 S2 S3 S4 Area #		Open	: _ M	: _ M	: _ M	: _ M	: _ M	: _ M	: _ M	: _ M	: _ M	: _ M
		Close	: _ M	: _ M	: _ M	: _ M	: _ M	: _ M	: _ M	: _ M	: _ M	: _ M
S1 S2 S3 S4 Area #		Open	: _ M	: _ M	: _ M	: _ M	: _ M	: _ M	: _ M	: _ M	: _ M	: _ M
		Close	: _ M	: _ M	: _ M	: _ M	: _ M	: _ M	: _ M	: _ M	: _ M	: _ M
S1 S2 S3 S4 Area #		Open	: _ M	: _ M	: _ M	: _ M	: _ M	: _ M	: _ M	: _ M	: _ M	: _ M
		Close	: _ M	: _ M	: _ M	: _ M	: _ M	: _ M	: _ M	: _ M	: _ M	: _ M
S1 S2 S3 S4 Area #		Open	: _ M	: _ M	: _ M	: _ M	: _ M	: _ M	: _ M	: _ M	: _ M	: _ M
		Close	: _ M	: _ M	: _ M	: _ M	: _ M	: _ M	: _ M	: _ M	: _ M	: _ M
S1 S2 S3 S4 Area #		Open	: _ M	: _ M	: _ M	: _ M	: _ M	: _ M	: _ M	: _ M	: _ M	: _ M
		Close	: _ M	: _ M	: _ M	: _ M	: _ M	: _ M	: _ M	: _ M	: _ M	: _ M
S1 S2 S3 S4 Area #		Open	: _ M	: _ M	: _ M	: _ M	: _ M	: _ M	: _ M	: _ M	: _ M	: _ M
		Close	: _ M	: _ M	: _ M	: _ M	: _ M	: _ M	: _ M	: _ M	: _ M	: _ M
Door # Output #		Open	: _ M	: _ M	: _ M	: _ M	: _ M	: _ M	: _ M	: _ M	: _ M	: _ M
		Close	: _ M	: _ M	: _ M	: _ M	: _ M	: _ M	: _ M	: _ M	: _ M	: _ M
Door # Output #		Open	: _ M	: _ M	: _ M	: _ M	: _ M	: _ M	: _ M	: _ M	: _ M	: _ M
		Close	: _ M	: _ M	: _ M	: _ M	: _ M	: _ M	: _ M	: _ M	: _ M	: _ M
Door # Output #		Open	: _ M	: _ M	: _ M	: _ M	: _ M	: _ M	: _ M	: _ M	: _ M	: _ M
		Close	: _ M	: _ M	: _ M	: _ M	: _ M	: _ M	: _ M	: _ M	: _ M	: _ M
Door # Output #		Open	: _ M	: _ M	: _ M	: _ M	: _ M	: _ M	: _ M	: _ M	: _ M	: _ M
		Close	: _ M	: _ M	: _ M	: _ M	: _ M	: _ M	: _ M	: _ M	: _ M	: _ M

Holiday Date Record

Your system has up to 20 holiday dates available that supercede all regular scheduled times for that day.

#	Date (mm/dd)	HOL (circle one)
1.	____/____	A or B or C
2.	____/____	A or B or C
3.	____/____	A or B or C
4.	____/____	A or B or C
5.	____/____	A or B or C
6.	____/____	A or B or C
7.	____/____	A or B or C
8.	____/____	A or B or C
9.	____/____	A or B or C
10.	____/____	A or B or C
11.	____/____	A or B or C
12.	____/____	A or B or C
13.	____/____	A or B or C
14.	____/____	A or B or C
15.	____/____	A or B or C
16.	____/____	A or B or C
17.	____/____	A or B or C
18.	____/____	A or B or C
19.	____/____	A or B or C
20.	____/____	A or B or C

Output Relay Record

Your system has ____ output relays that are used to control various functions within the building or access around its perimeter. Below is a list of the devices they control.

Output #	Output Name
_____	_____
_____	_____
_____	_____
_____	_____
_____	_____
_____	_____
_____	_____
_____	_____
_____	_____
_____	_____
_____	_____
_____	_____
_____	_____
_____	_____
_____	_____
_____	_____
_____	_____
_____	_____
_____	_____
_____	_____
_____	_____

Use the Output number in the User Menu when setting Output Schedules or using the Outputs ON OFF option to manually toggle the relays.

Appendix A

About the Display Events Section

This section of the user's guide shows the User's Guide Display Events items for both 16-character (single line) and 32-character keypad displays. While in the Display Events function, use the COMMAND and Back Arrow keys to go forward or backward through the list of events.

To view more information about each display, press the Select key as directed in the explanations below. Remember that the Select keys are numbered from left to right for the purpose of this manual. The actual Select keys on your keypad will not be numbered or labeled.

Arming and Disarming Event Displays

This displays any arming or disarming of system areas.

16-Character Display

Description

ARM 3 12 1017

Area 3 was armed by user 12 on Oct. 17. Press the second Select key, under 3, for the area name, the third key for the user name, or the fourth key for the time the arming occurred.

32-Character Display

Description

**ARM 5:10P 10/17
WAREHOUSE**

The area was armed at 5:10 PM. Press any Select key to display the area number and user number, and then any Select key to display the user name.

Arming Event Types - There are 2 event type you may see here:

ARM - User armed the system **DIS** - User disarmed the system

Zone Event Displays

This displays alarms, troubles, and other events that could occur on your protection zones.

16-Character Display

Description

2 BURG ALR 1017

A burglary alarm occurred on zone 2. Press the fourth Select key for the time the alarm occurred.

32-Character Display

Description

**ALR 10:23P 10/17
BASEMENT DOOR**

An alarm occurred at 10:23 PM on Oct. 17. Press any Select key to see the zone number and zone type.

Zone Type - There are 7 possible zone types you may see here.

FIRE - Fire

PANC - Panic

BURG - Burglary

EMRG - Emergency

SUPV - Supervisory

AUX1 - Auxiliary 1

AUX2 - Auxiliary 2

Event Types - There are 7 event type you may see here:

ALR - Alarm

TBL - Trouble

RST - Restore

LOW - Low battery

MIS - Missing wireless transmitter

FLT - Zone Fault

SVC - Service smoke detector

Note: **LOW** and **MIS** are for wireless systems only.

User Code Change Event Displays

This displays any addition, deletion, or change to a user code.

16-Character Display

12 ADD 19 1017

Description

User 12 added user 19 on Oct. 17. Press the *right* Select key for the time this occurred.

32-Character Display

**ADD 11: 41A 10 /17
US:19 BY US:12**

Description

User 19 added by user 12 at 11:41 AM. Press the Select key under either user (US:) number for the user name.

User Code Event Types - There are 3 event type you may see here:

ADD - User added **DEL** - User deleted

CHG - User code or authority level has been changed.

Supervisory Event Displays

This displays the date and time of an automatic test report.

16-Character Display

AUTO RECALL 1017

Description

The test report was sent on Oct. 17.

32-Character Display

**MSG 11: 58P 10 / 17
AUTO RECALL**

Description

The test report was sent to the central station at the date and time shown.

System Monitor Event Displays

This displays any problems with the system's AC power, battery, or phone line(s) or any opening of a tampered panel box.

16-Character Display

Description

POWER TBL 1017

An AC failure occurred on Oct. 17. Press the fourth Select key for the time.

32-Character Display

Description

**TBL 11:41A 10/17
POWER**

An AC failure occurred at 11:41 AM on Oct. 17.

System Monitor Event Types - There are 2 event types:

TBL - Trouble **RST** - Restore

System Monitor Event Names - There are 5 system monitors:

POWER - AC power to panel **BATTERY** - On panel

LINE 1 - Phone line number 1

LINE 2 - Phone line number 2 **TAMPER** - On panel box

Door Access Event Displays

This displays the keypad address where a Door Access occurred and the user number of the person granted access.

16-Character Display

Description

DOOR 3 024 1017

Door (keypad) #3 was accessed by user 24 on Oct. 17. Press the second Select key to display the reason that access was denied. Press the third to display the user name and the fourth Select key for the time of occurrence.

32-Character Display

Description

**ACC 5:18P 10/17
3 USER:024**

Door (keypad) #3 was accessed by user 24 at 5:18 PM on Oct. 17. Press the first Select key to display Door name where to access occurred. Press the second Select key to display the reason that access was denied. Press the third Select key for the name of the device, or the fourth key for the user name.

About Door Access

Door Access is a feature available on certain Security Command keypads that contain a built-in door releasing relay and proximity readers. When power for an electric door strike or magnetic lock is connected to the relay's contacts, only users entering a valid user code can release the lock and gain access to the area.

The Display Events feature logs the user number and name of the person granted access, the date and time, and from which keypad they entered their code.

Schedule Change Event Displays

This displays Changes made to the system's schedules.

16-Character Display

Description

S1 MON 024 1017

S1 schedule for Monday was changed by user 24 on Oct. 17. Press the fourth Select key for the time of occurrence or the third Select key for the user name.

32-Character Display

Description

**S1 9:41A 10/17
USER:024**

S1 schedule for Monday was SCH changed by user 24 at 9:41 AM on Oct. 17.

Schedule Types - There are 5 possible schedule types:

S1 S2 S3 S4 - Standard **OUT** - Output **DOOR** - Door

HOL - Holiday **EXT** - Extend

MON - This is the day of the week in which the schedule change occurred. The days are displayed using three letters. Press the first Select key to display the scheduled Opening time and once again for the scheduled Closing time.

024 - User number of the person who made the change. Press the third Select key (the Select key under 024) to display the user's name.

Zone Bypass Event Displays

This displays the bypassing of system zones.

16-Character Display

Description

26 BYPS 12 1017

Zone 26 bypassed by user 12. Press the first Select key for the zone name and the fourth Select key for the time.

32-Character Display

Description

**BYP 5:18P 10 / 17
EAST WINDOW**

The east window zone was bypassed. Press a Select key for the zone number and user number. Press again for the user name.

Bypass Event Types - There are 3 event types:

BYP - Bypass **RST** - Restore **FRC** - Force Arm

Note: You may sometimes see the user as **SWG**. This is short for Swinger Bypass which is an automatic function that allows the system to bypass a zone.

Outputs On/Off Browser

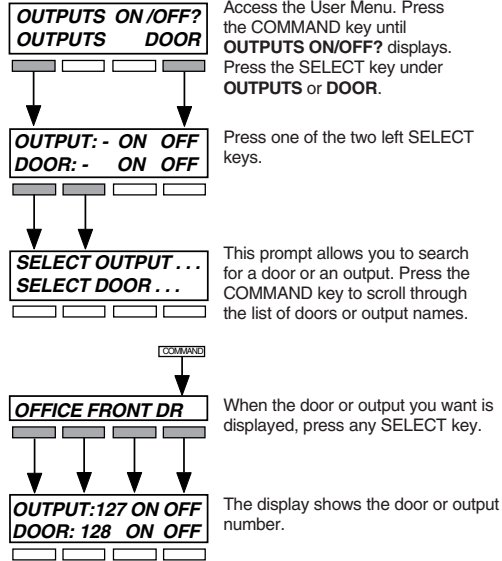

Appendix B

Zone Status Browser

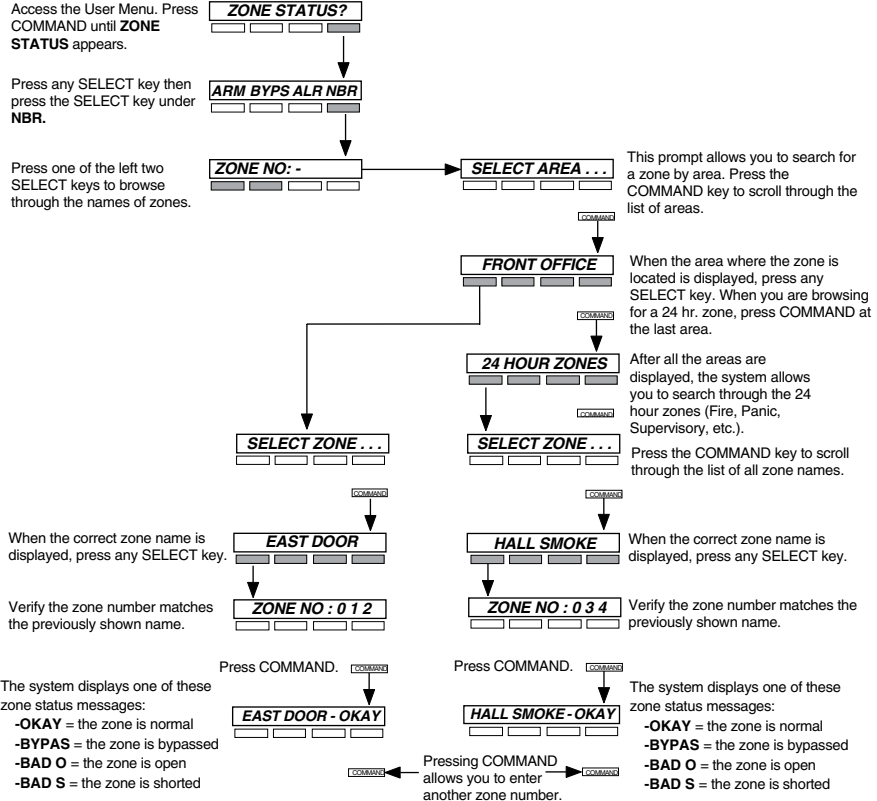

Bypass Zones Browser

Access the User Menu. Press COMMAND until **BYPASS ZONES** appears. Press any SELECT key.

Press either of the two left SELECT keys.

This prompt allows you to search for a zone by area. Press the COMMAND key to scroll through the list of areas.

When the area where the zone is located is displayed, press any SELECT key.

BYPASS ZONES?
[] [] [] []

ZONE: - RST BYP
[] [] [] []

SELECT AREA . . .
[] [] [] []

COMMAND

FRONT OFFICE
[] [] [] []

SELECT ZONE . . .
[] [] [] []

Press the COMMAND key to scroll through the list of all zone names.

COMMAND

EAST DOOR
[] [] [] []

When the correct zone name is displayed, press any SELECT key.

The display shows the zone number. Press the SELECT key under **RST** to Reset the zone. Press the SELECT key under **BYP** to Bypass the zone.

ZONE:012 RST BYP
[] [] [] []

ZONE: - RST BYP
[] [] [] []

The display returns to the **ZONE:** prompt allowing you to enter another zone number.

Zone Monitor Browser

Access the User Menu. Press COMMAND until **ZONE MONITOR?** displays. Press any SELECT key.

Press the SELECT key under **NBR**.

Press either of the two left SELECT keys.

This prompt allows you to search for a zone by area. Press the COMMAND key to scroll through the list of areas.

When the area where the zone is located is displayed, press any SELECT key.

Press the COMMAND key to scroll through the list of all zone names.

COMMAND

EAST DOOR
[] [] [] []

When the correct zone name is displayed, press any SELECT key.

The display shows the zone number.

ZONE:012 ADD RMV
[] [] [] []

Selecting **ADD** puts the zone in the monitor mode.

Selecting **RMV** removes the zone from the monitor mode.

ZONE MONITOR?
[] [] [] []

ALL NBR
[] [] [] []

ZONE: - ADD RMV
[] [] [] []

SELECT AREA . . .
[] [] [] []

COMMAND

FRONT OFFICE
[] [] [] []

SELECT ZONE . . .
[] [] [] []

Add User Profiles Browser

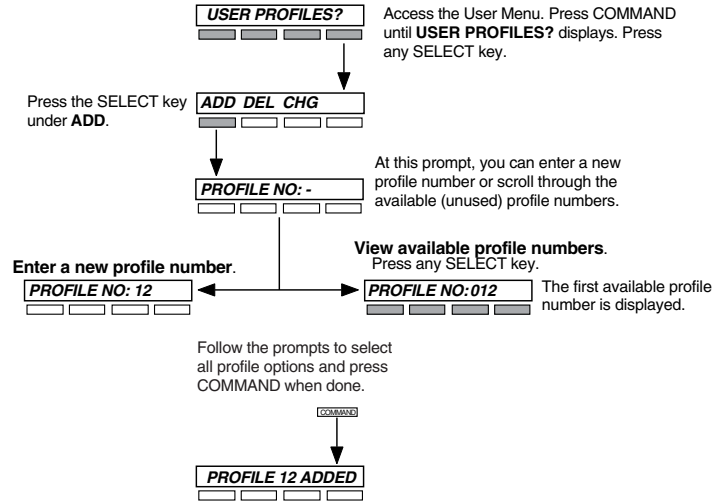

Delete User Profiles Browser

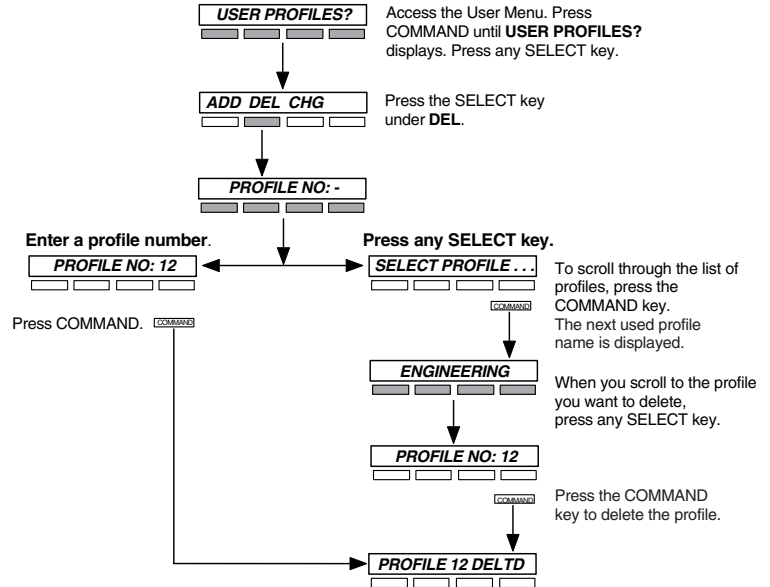

Change User Profiles Browser

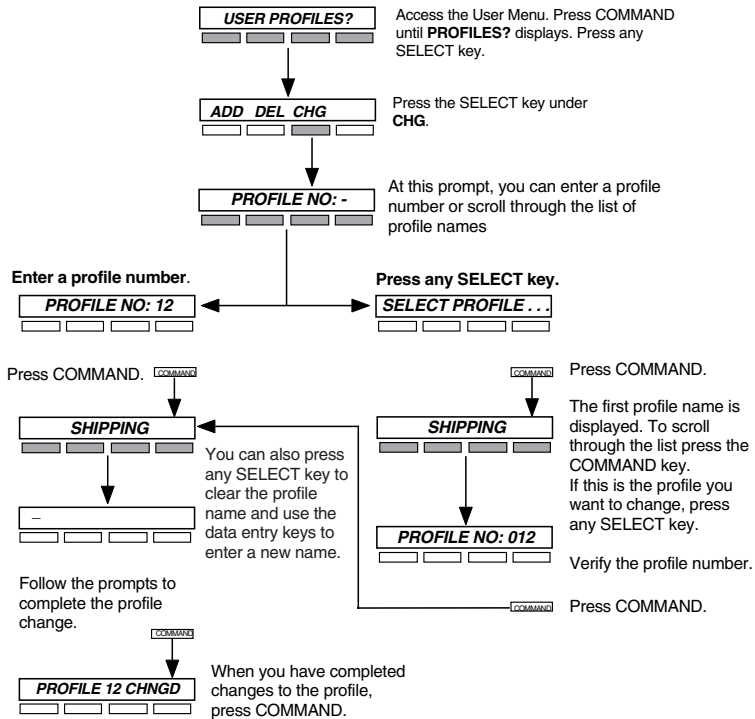

Add User Codes Browser

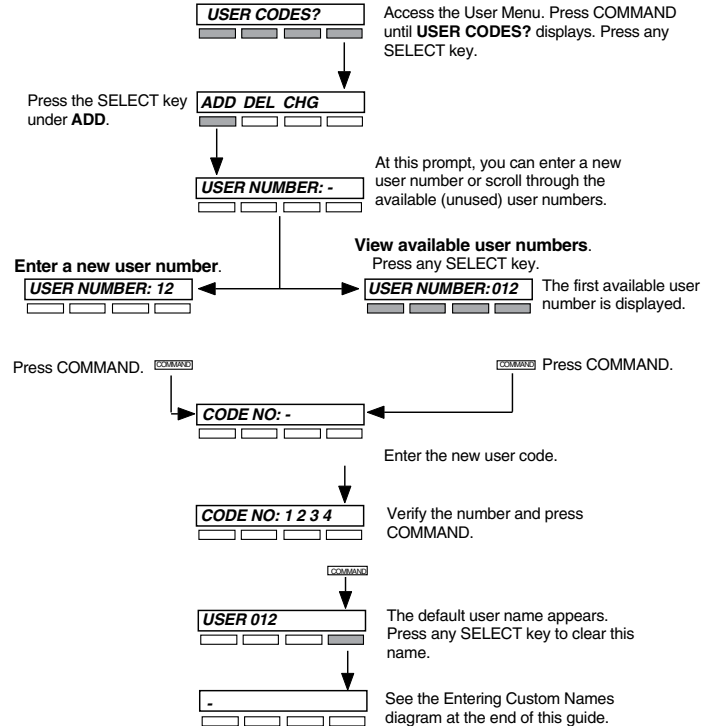

Delete User Codes Browser

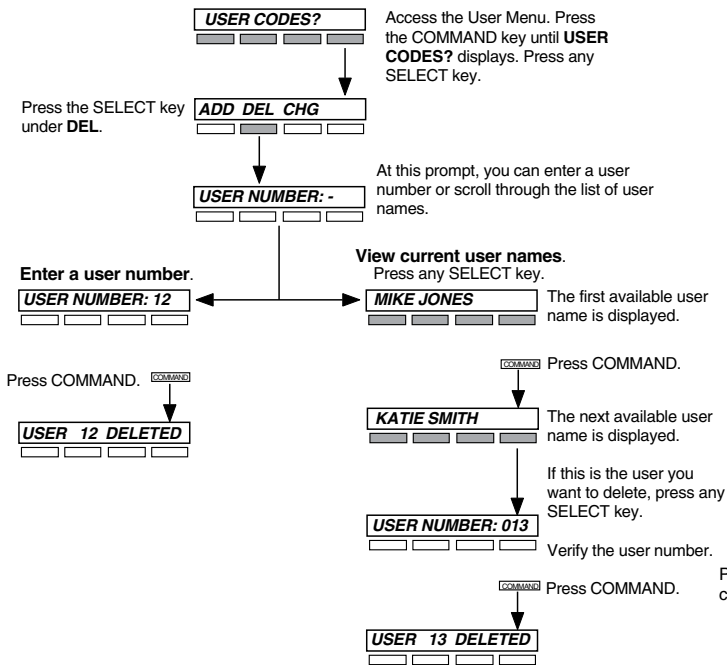

Change User Codes Browser

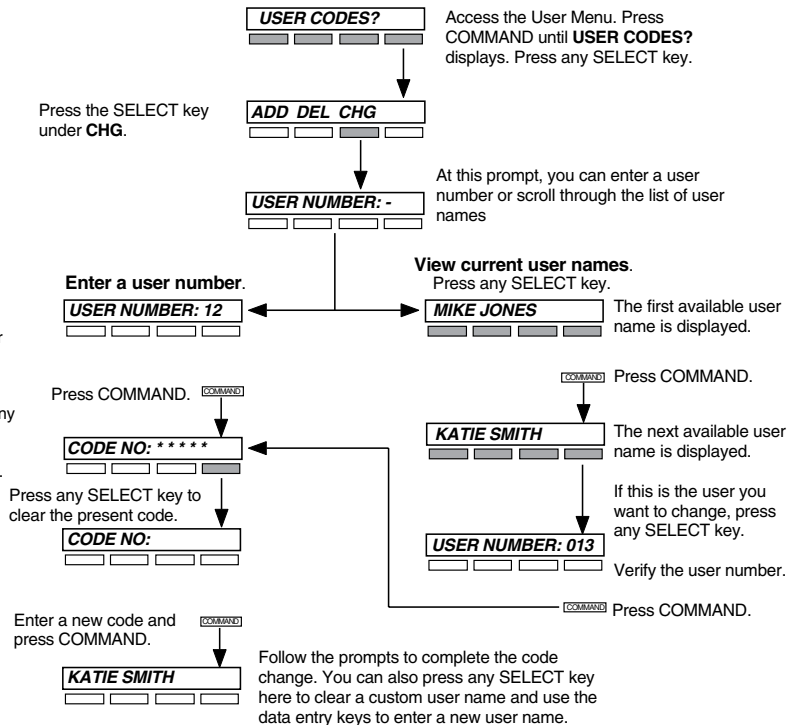

Output Groups Browser

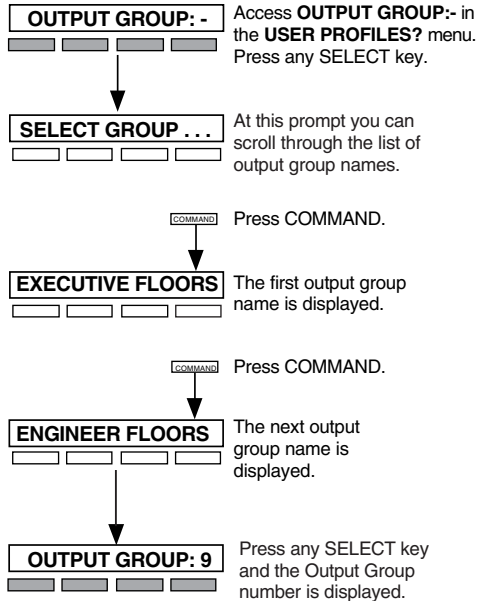

Entering User Names

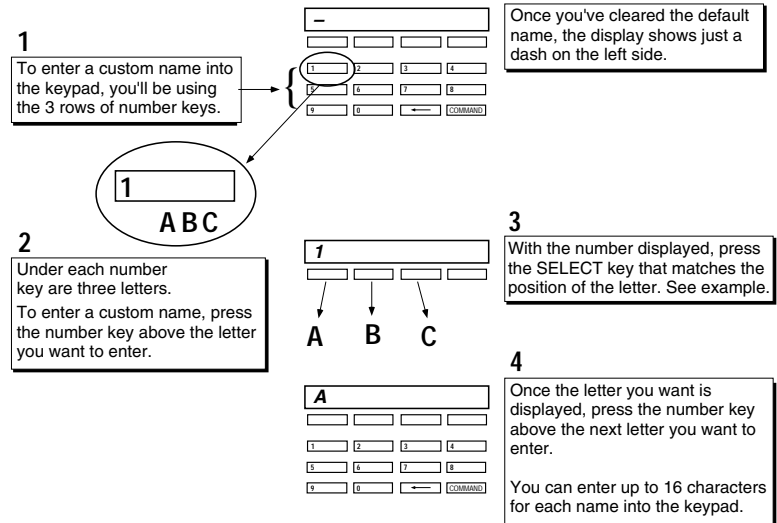

The nine and zero keys . . .

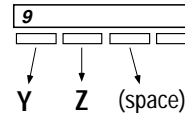

Pressing the **9** key provides you with Y, Z, and a space that you can use between names. For example: BOB SMITH.

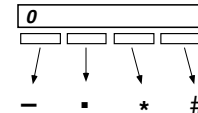

Pressing the **0** (zero) key provides you with a (dash), (period), (asterisk), and a (pound sign).

Easy Entry™ User's Guide

DOORSTRIKE

From the Status List, present your card to the reader. Once it is validated by the system, the Door Strike relay activates. If you are entering an armed area which you are assigned, accessing the area will automatically cause it to be disarmed.

While the keypad is in the Status List, present your access card. The relay activates momentarily during which you must open the door. Once you open the door, you have 30 seconds to exit and close the door before the zone 2 Soft-Shunt expires.

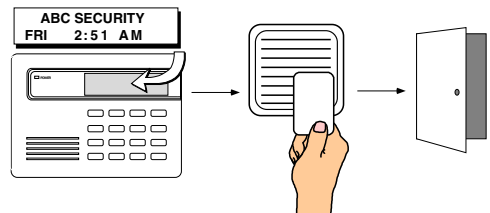

ARMING AND DISARMING AN AREA SYSTEM

Press Command. The keypad displays **ARM DISARM**. Press the Select key under either option. The keypad displays **ENTER CODE: -**. Present your card to the reader. Once it is validated by the system, all areas accessible by you arm or disarm automatically. Select **NO** to arm or disarm individual areas. Select **YES**, or simply wait, and the keypad will automatically arm or disarm all areas for which you are authorized.

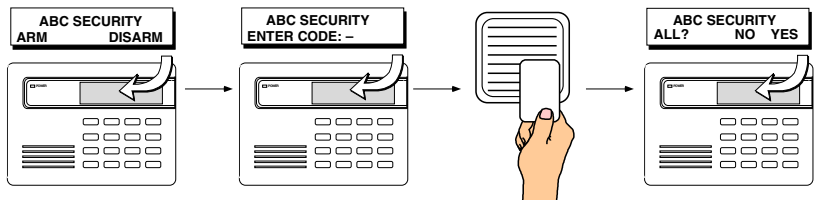

DISARMING WITH ENTRY DELAY

Once the protected door is opened and the entry delay starts, the keypad displays **ENTER CODE: -**. Present your card to the reader. Once it is validated, the system disarms all areas accessible by you. Area systems provide a delay to allow selected areas only to be disarmed. See Arming and Disarming above.

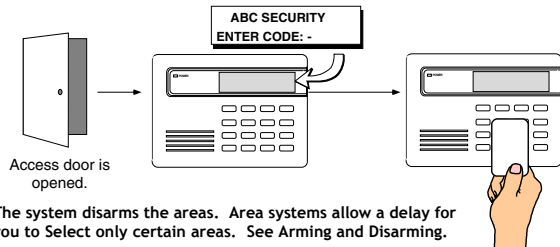

The system disarms the areas. Area systems allow a delay for you to Select only certain areas. See Arming and Disarming.

USING THE ACCESS READER FOR USER MENU ACCESS

You can also use a card reader to access the User Menu when the **MENU? NO YES** display is shown and a code is requested.

Pager Direct™ User's Guide

Pager Direct uses the reporting capability of your security system to dial your pager number and send reports much like someone sending you a pager message. You can receive reports of alarms, troubles, or armings and disarmings of the system and know at a glance the status of your system.

Area Names

List your system's area names and numbers below:

Area	Name	Area	Name
1 _____		3 _____	
2 _____		4 _____	

Service Department Phone: _____

Emergency Phone: _____

Central Station Phone: _____

Pager Direct™



Security Command Numeric Paging

Cut along dotted lines

Area Names

List your system's area names and numbers below:

Area	Name	Area	Name
1 _____		3 _____	
2 _____		4 _____	

Service Department Phone: _____

Emergency Phone: _____

Central Station Phone: _____

Pager Direct™



Security Command Alphanumeric Paging

Cut along dotted lines

Alphanumeric Pager Display

Account Number

Whenever the system sends a message to your pager, it will always send the account number first to identify itself. After the account, you will see the following messages:

Typical Zone Event Display Description

20002 001 NORTHWEST DOORS BURG *ALARM* SHIPPING

Account	Zone	Zone Name	Zone Type	Event	Area Name
---------	------	-----------	-----------	-------	-----------

Zone Types - BURG, FIRE, SUPV (Supervisory), PANC (Panic), EMRG (Emergency), AUX1, or AUX2

Events - ALARM or TROUBLE

Typical Arming/Disarming Display Description

20002 ARMED 0016 01 EAST WAREHOUSE

Account	Event	User #	Area #	Area Name
---------	-------	--------	--------	-----------

Events - ARMED or DISARMED

Typical System Event Display Description

20002 LATE TO CLOSE

Account	Event
---------	-------

Events - LATE TO CLOSE (The system was not armed at its scheduled closing time)
ALARM CANCELLED (An alarm has been cancelled by an authorized user)

Security Command Alphanumeric Paging

Numeric Pager Display

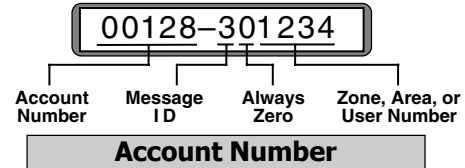

This number has been programmed into your Security Command system as an identifier. Whenever the system sends a message to your pager, it will always send the account number first to identify itself.

Message ID

This is always a single digit, 1 to 7, that describes the message.

- | | |
|-----------------------|-------------------|
| 1 = Zone Alarm | 5 = Late to Close |
| 2 = Zone Trouble | 6 = User Check-in |
| 3 = Area(s) Arming | 7 = Local Message |
| 4 = Area(s) Disarming | |

Zone, Area, or User Number

If this message is for a zone, the 1- to 3-digit zone number is displayed. If this message is for areas that are being armed or disarmed, the area numbers are shown in sequential order. Example: 1 2 4.

Security Command Numeric Paging

FA113 User's Guide

These instructions guide you through the operation of your system using the FA113 Wireless Keychain Remote. The FA113 uses the audible output capability of the Security Command keypad to sound confirmation tones. It is recommended that you use the FA113 within hearing distance of these keypads.

Disarming the System

1. Press the **OFF** button once. The Security Command keypads emit a single two second beep to confirm the disarming.

Arming an Area System

1. Press the **ON** button once to arm the following areas:
 1. _____
 2. _____
 3. _____
 4. _____

The Security Command keypads emit a single beep to confirm the arming.

Disarming an Area System

1. Press the **OFF** button once to disarm the above areas. The keypads emit a single beep to confirm the disarming.

Using the ALERT Buttons

Pressing the two **ALERT** buttons simultaneously sends a Panic alarm to the panel. If your system is monitored by a central station, the proper authorities will be notified of the alarm.

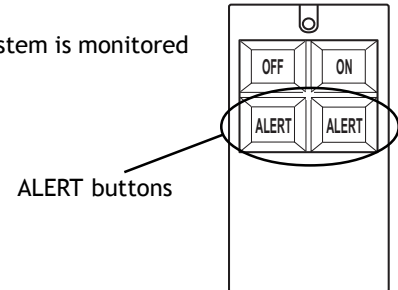

Frequently asked questions

This section attempts to answer questions you might have regarding the operation of your Security Command system.

Q. If I bypass an exit delay door when I arm the system, will I get an alarm if I come through it later?

A. You will not get an alarm from the door because it is bypassed, but if you also walk through a motion detector or other armed door inside the premises you will get an alarm.

Q. When I arm or disarm my Area system, I get **ALL? NO YES** displayed. Does this mean all areas in the system?

A. Choosing **YES** arms or disarms all areas that are authorized for your user code.

Q. How do I create a schedule that starts at 8:00 am on Monday and ends at 5:00 PM on Friday.

A. In the days of the week display, select **MON** (Monday). For the **OPENING TIME?**, enter 0 + 8 + 0 + 0 AM. For the **CLOSING TIME?**, at the **MON – : AM PM** display press the Select key under **MON**; this scrolls through the days of the week. Stop at the day you want the schedule to end. Next, enter 0 + 5 + 0 + 0 PM into the **FRI – : AM PM** closing time display. Press **COMMAND**. Press the Back Arrow key to exit the User Menu.

This sets the opening time to 8:00 am Monday and the closing time to 5:00 PM Friday. You can substitute any other day or time in this example.

Q. What do I do if I want to be in the building past the scheduled closing (arming) time?

A. If your system is programmed for closing check, the keypad emits a steady tone prior to the system arming. During this tone, pressing any Select key displays **ENTER CODE: .** Enter your user code and press **COMMAND**.

The keypad now displays the enter time display – : **AM PM**. Enter in the new time you want the system to arm and press **COMMAND**. The time you enter may extend past midnight by pressing the **AM** key after the appropriate time has been entered.

Appendix D

Common Keypad Displays

Listed below are several keypad messages you may see on the display. Follow the instructions in the Possible Solutions column to correct the problem. In many cases, you will need to call a service person to correct the problem.

Message	Meaning	Possible Solutions
Invalid Area	The user has attempted a door access for an area they are not assigned.	Assign the user access to this area if desired; otherwise the user cannot access the area.
Invalid Code	The user code you have entered is not recognized by the system.	Check the user code and try again.
Invalid Level	The code you have used does not have the authority level to access the desired option.	Check the user level to see if you have the correct level set for the code. Remember that you can only grant a user authority if you have the same authority or greater: You can't give what you don't have.
Invalid Profile	A user has attempted a function that is outside of the assigned profile.	Check the user's profile settings.
Invalid Time	A user code assigned to a specific schedule has entered outside of the valid schedule.	See Schedules and User Codes.
Enter 2nd Code	The area you are attempting to disarm or access is a Two Man area.	A second and different user must enter a valid user code.
Closing Time	The schedule has expired but the area has not been armed.	Users still on the premises are reminded to arm the system or extend the schedule to a later time.
Late to Close	The system was not armed at its scheduled closing time.	Users still on the premises are reminded to arm the system or extend the schedule to a later time.
Failed to Exit	A user assigned the anti-pass back option has attempted to re-enter an area which they did not exit properly.	The user must exit the area through the proper door. If not possible, your system administrator should select the Forgive option in the User Codes menu option.

Common Keypad Displays Continued

Message	Meaning	Possible Solutions
AC Trouble	The system is not getting proper power.	Contact your representative.
Battery Trouble	Battery is either low or missing.	Contact your representative.
Phone Line 1 Trouble	The panel is looking for phone jack supervision.	Contact your representative.
System Trouble or Service Required	There is a problem with one or more of the components in the system.	Contact your representative.
System Busy	The system is performing another task with a higher priority.	Contact your representative.
4-Wire Bus Trouble	No supervised device on bus	Contact your representative.
	Low Voltage or an open yellow wire	Contact your representative.
	Two devices on same address	Contact your representative.
Transmit Trouble	The panel has attempted to communicate with the central station 3 times and has not succeeded.	Contact your representative.
Transmit Fail	The panel has attempted to communicate with the central station 10 times and has not succeeded.	Contact your representative.
Wireless Trouble	The wireless receiver is not communicating with the 472 Hard-Wire-Less Card.	Contact your representative.
Non-Polled Address	The device is not set to STD (standard) or FIRE in Device Setup of programming.	Contact your representative.

Index

2-Button Panic Keys	3	Display Events	32, 42	LED	Security Command Keypad	1, 3
485B System Setup Record	37	Arming and Disarming Event	42	AC	Record	37
Alarm Silence	13	Door Access Event	45	Armed	Sensor Reset	13
ALERT Buttons	55	Schedule Change Event	45	Outputs On Off	Service Request	34
Ambush Codes	26	Supervisory Event	44	Panic Zone Test	Status List	7
Anti-Pass Back	5	System Monitor Event	44	Profiles	System Setup Record	36
AREA LATE!	27	User Code Change Event	44	Adding	System Status	18
Area Names and Numbers Record	38	Zone Bypass Event	53	Changing	System Test	19
Armed Areas Display	15	Zone Event	43	Deleting	TEMP CODE	22
Arming	8	Door Access	14	Name	Two Man Rule	34
Bank Safe & Vault	36	Early Morning Ambush	34	Number	User Codes	23
Browser	53	Extending Schedules	11, 30	Schedules	Adding	23
Add User Codes	53	FA113 User's Guide	55	Extend (EXT)	Changing	24
Add User Profiles	53	Failure to Exit	25	Extending Schedules	Deleting	24
Bypass Zones	53	False Alarms	1	Setting Shift Schedules	Names	23
Change User Codes	53	Fire Drill	34	Schedules	Profile	23
Change User Profiles	53	Forgive Failure to Exit	25	Extending Schedules	User Menu Options	12
Delete User Codes	53	Frequently asked questions	56	Holiday (HOL)	User Options Menu	4
Delete User Profiles	53	General Arming Operation	8	Output (OUT)	User Profiles	20
Outputs On/Off	53	General Disarming Operation	10	Setting Holiday ABC Schedules	XR200-485B Panic Test	20
Zone Monitor	53	Holiday Date		Setting Output and Door	Zone Monitor	17
Zone Status	53	Setting Holiday Dates	30	Schedules	Zone Status	16
Bypass Zones	17	Holiday Date Record	41	Shift (S1, S2, S3, S4)		
Bypassing when arming		Keypad		Schedules Record		
bad loops	3	2-Button Panic Keys	3			
CLOSING TIME!	27	Back Arrow Key	3			
Common Keypad Displays ...	57, 58	Command Key	3			
Date and Time	31	Data Entry Keys	3			
Disarming	10	Tones	4			
		User Menu	1, 12			
		Wireless Displays	5			

